

Massachusetts Bay Transportation Authority

Bus Stop Planning & Design Guide

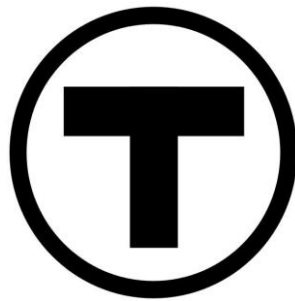

FINAL

April 2018

TABLE OF CONTENTS

1.	INTRODUCTION	3
2.	BUS STOP PLACEMENT	6
3.	BUS STOP SPACING.....	17
4.	BUS STOP LENGTH AND CONFIGURATION.....	22
5.	BUS STOP ACCESSIBILITY & SIDEWALK ENVIRONMENT.....	28
6.	BUS STOP AMENITIES	36
7.	SHELTERS	45
8.	SIGNAGE & CUSTOMER INFORMATION	55
9.	BUS TURNOUTS AND CURB EXTENSIONS.....	59
10.	OTHER BUS STOP ELEMENTS	63
11.	TRANSIT PRIORITY MEASURES	70

APPENDICES

- APPENDIX A: REFERENCE DOCUMENTS
- APPENDIX B: CONTACT INFORMATION
- APPENDIX C: AMENITY APPROVAL PROCESS
- APPENDIX D: TYPICAL MBTA BUS SHELTER DETAIL

1. INTRODUCTION

The bus stop is the first point of contact between the customer and the bus service. The location, design, and functionality of bus stops significantly influence transit system performance and customer satisfaction. MBTA bus stops serve over 380,000 daily customers, or over 30% of all MBTA ridership, and are a critical component of Metropolitan Boston's transportation network. The MBTA strives to serve all customers equally, be they commuters, tourists, students, senior citizens, or persons with disabilities. To do this, the MBTA is committed to the goal of providing safe, accessible, comfortable and convenient bus stop facilities.

Purpose & Use

This document defines the MBTA's bus stop planning and design guidelines and criteria to be considered during the planning and design of bus corridors, stops and facilities.

The overall goals of this guide are to:

- Define minimum criteria for bus stop safety, accessibility and operations
- Promote consistency in bus stop placement and design
- Support bus service operational improvements relating to reliability and schedule adherence
- Encourage local jurisdictions, developers and businesses to design bus stops that are serviceable by the MBTA, and meet operational standards
- Promote greater use of transit through the provision of safe, comfortable, accessible and convenient transit facilities

This guide can assist transit agencies, local governments, consultants, developers and other entities in locating and designing bus stops. The general public may also find this guide useful in understanding the MBTA's standards, goals and preferred practices.

This document provides guidelines, standards and criteria for the planning, design and placement of bus facilities and must be used in conjunction with sound evaluation of the facts and engineering judgment. Users of this document will need to also consider the needs, constraints and applicable laws, regulations, and ordinances of each particular bus stop site. Each particular project must be evaluated with respect to safety, operational requirements and cost-effectiveness, and design solutions may need to be adjusted accordingly to satisfy specific constraints and applicable local ordinances. If the user has any questions or seeks expert advice concerning the information in this Guide, they should contact the Service Planning Unit of the MBTA.

The Planning, Design and Review Process

The user of this Guide is best served by adhering to the following process that will help ensure that all bus stops are properly planned, designed and constructed. Where appropriate, Chapters from this Guide document are referenced.

1. If there are bus stops and/or bus services operating within or adjacent to the project limits, coordinate with the MBTA Service Planning Department or other entity that operates the bus service.
2. Coordinate the project with the controlling entity. Buses typically operate on roadways not owned or controlled by the transit operator and generally fall under the jurisdiction of either the State or the local Municipality. For projects funded by the State and/or proposed for State owned roadways, ongoing coordination and design review is handled by the local MassDot District office and the Chief Engineer. Coordination is also required with local and state planning agencies.
3. Identify existing and potential future bus service characteristics. This may include service frequency, boardings and alightings, run times and bus types. This information is typically provided by the MBTA Service Planning Department or the local transit planning agency.
4. Determine preferred locations of bus stops. Factors to be considered include safety, accessibility, bus service optimization, bike, auto and pedestrian traffic, abutting land use and sidewalk characteristics (See Chapter 2).
5. Determine preferred spacing of bus stops along corridor or adjacent to the project area, based on service and ridership characteristics. (See Chapter 3).
6. For shelter and bench placement, determine if amenity meets the eligibility standards and if site meets the suitability test, including Title VI requirements (See Chapters 6 and 7).

All design and construction plans and documents shall be submitted for review to the MBTA Service Planning Department and/or other controlling entities. Coordination and submittals should take place during project development and at all project design phases.

Bus Service and Fleet Characteristics

The MBTA bus network includes approximately 170 routes, serving over 8,100 bus stops in 65 municipalities. Four routes on the Silver Line (SL1, SL2, SL4 and SL5) incorporate some Bus Rapid Transit (BRT) components and 15 bus routes (1, 15, 22, 23, 28, 32, 39, 57, 66, 71, 73, 77, 111, 116 and 117) are designated as Key Bus Routes because of their high ridership and frequency of service. The MBTA also utilizes several private companies to operate service on less than a dozen routes.



The MBTA active bus fleet consists of over 1,000 buses, of which approximately 800 serve MBTA bus routes during peak periods. The fleet consists of both 40' and 60' buses fueled by diesel, compressed natural gas (CNG), hybrid electric, dual mode and overhead electric power sources. The entire fleet consists of low floor accessible buses equipped with a deployable front door ramp. Details on the bus fleet are provided in Appendix A. For design purposes, the following bus parameters should be assumed:

Bus width: 8'-6" (10'-6" including mirrors)

Bus height: 11'-6"

Bus Length: 40' or 60'

Door spacing and other parameters are presented elsewhere in this document.

Improving Bus Service

This Guide is also intended to promote improvements that will have a positive net impact on bus service. The primary measures of high quality bus service include schedule adherence and trip times. The following elements are discussed in these guidelines and have varying levels of impact on bus service:

- Uniform bus stop spacing
- Proper placement of bus stops (near-side, far-side, mid-block)
- Elimination of underutilized stops
- Curb extensions, bulb outs and turnouts where appropriate
- Transit Signal Priority, Queue Jump and exclusive bus Lanes

2. BUS STOP PLACEMENT

Proper bus stop placement is critical to the safety of customers, pedestrians, cyclists and motorists, and for efficient bus operations. This section discusses bus stop placement and types of bus stops. Stop consolidation is discussed in Chapter 3. Bus stop placement should take into consideration the following:

- Proximity to cross street (near-side, far-side, mid-block)
- Proximity to expected customer trip generators
- Pedestrian safety and access to stop; accessibility of nearby sidewalks, curb ramps, etc.
- Stop spacing along the route
- Availability of sidewalk and curb
- Adequate right-of-way and sidewalk width to accommodate accessibility and amenities
- Adequate curbside space for single or multiple bus operations
- Proximity to transit transfer points
- Impact on existing street parking
- Potential for transit signal priority and/or a queue jump lane
- Impact on adjacent property owners
- Impact on other transit vehicles, vehicular traffic, bicycles and pedestrians
- Proximity and usage of nearby driveways
- Street and sidewalk grades, curb height
- Unusual intersection angles or predominant turning movements
- Sight distance at adjacent intersections and driveways
- Availability of existing amenities (shelter, seating, etc.)



All proposals to add, remove, alter, relocate or consolidate a bus stop shall be reviewed and approved by the MBTA and the municipality, or other local governing authority having jurisdiction over the roadway, sidewalk, bus stop zone and/or curb area. The approval process varies by municipality. See Chapter 1 for the MBTA review and approval process.

Bus stops are generally located at intersections on the near-side or far-side of an intersecting cross street. This maximizes pedestrian accessibility from both sides of the street and minimizes parking impacts. Under certain situations, bus stops may also be placed at a mid-block location. Table 2.1 summarizes the major advantages, disadvantages and recommendations related to locating bus stops. Bulb outs or curb extensions allow buses to stop in the travel lane. Buses have long been expected to pull out of traffic to the curb, but this practice de-prioritizes transit, sometimes significantly on mixed-traffic streets. In-lane stops eliminate that delay. They also create shorter and safer pedestrian crossings, provide more walking space on the sidewalk, and make the street more predictable by sorting out bike-bus conflicts at stops. On single-lane streets where in-lane stops are most needed, far-side in-lane stops in mixed traffic may result in traffic behind the bus spilling back into the crosswalk and

intersection. At these locations, provide longer far-side stop that accommodates queued vehicles behind the stopped transit vehicle, or activate an early red phase after the bus clears the intersection. A periodic pull-out stop on streets with primarily in-lane stops allows vehicles to pass while a bus is stopped.

In general, far-side bus stop locations are safer for pedestrians, facilitate faster travel times, and have the least impact on parking. This placement allows buses to avoid conflicts with right turning vehicles, allows for safer boarding and alighting of customers, and works well with queue jump lanes at signalized intersections.

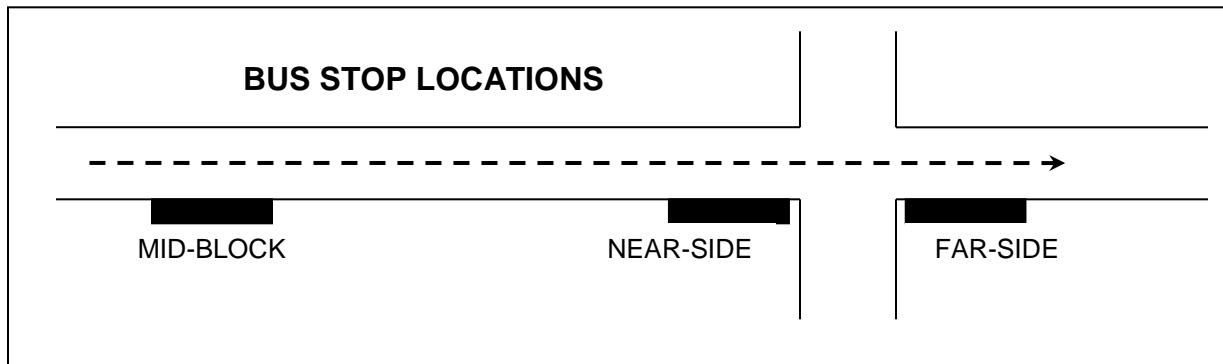

Mid-block stops are generally discouraged as they result in unsafe pedestrian mid-block crossings and require the greatest amount of curb space for buses to pull in and out of a bus stop. They are most likely to have enforcement problems with illegal parking and should be integrated with other curb uses whenever possible, such as fire hydrants, loading zones, crosswalks and driveways, to minimize parking impacts. Mid-block stops may benefit from additional roadway treatments including partial curb bulb-outs, raised crosswalks, and/or embedded or overhead pedestrian signals.

Other general considerations for the placement of bus stops at intersections include:

- When the route alignment requires a left turn, the preferred location for the bus stop is on the far-side of the intersection after the left turn is completed. If this is infeasible or undesirable, a mid-block stop is preferable and should be located at least 500 feet before the intersection so that a bus can subsequently maneuver into the proper lane to turn left.
- When the route alignment requires a right turn, the preferred location for the stop is after the bus has turned.
- For high usage stops where benches and/or shelters are recommended, preference should be given to the location that provides adequate space for customer amenities.



Table 2.1: Bus Stop Placement Considerations

	Where Recommended	Advantages	Disadvantages
Near-Side Stop	Traffic is heavier on the far-side of the intersection	Minimizes interference when traffic is heavy on far side of intersection	Increases sight line problems for crossing pedestrians
	Existing pedestrian conditions and movements are better than on the far-side	Allows boarding close to crosswalk. Pedestrians can cross while the bus is stopped and not moving into stop.	Increases conflicts with right-turning vehicles passing and turning in front of the bus
	Bus route continues straight through the intersection or the stop is set back a reasonable distance to enable right turn	Width of the intersection is available for the bus to pull away from curb and merge with traffic	May result in stopped buses obscuring curbside traffic control devices and crossing pedestrians
	When a curb extension prevents vehicles from turning right directly in front of a bus	Avoids double stopping for both traffic signal and customer movements	May block the through lane during peak periods with queuing buses
	Where the accumulation of buses at a far-side stop spill over into the intersection	Allows customers to board/alight while the bus is stopped at a red light	May cause sight lines to be obscured for vehicles exiting the side street to the right of the bus
Far-Side Stop	Traffic is heavier on the near-side of an intersection	Minimizes conflicts with turning vehicles	May result in traffic queued into intersection when a bus is stopped in travel lane
	At heavy right turns on major approach, or heavy left and through turns from side street	Provides additional right turn capacity by making curb lane available for traffic	May obscure/increase sight distance at the far-side crosswalk and for side streets
	When pedestrian conditions are better than the near-side	Encourages pedestrians to cross behind the bus	Pedestrian stepping off the curb as the bus approaches the bus stop
	Intersections that have priority treatments including Queue Jump Lanes and TSP	Creates shorter deceleration distances for buses and minimizes area needed for curbside bus zone	Vehicles occupying right turn only lanes and proceeding straight instead of turning, and cutting off bus approaching far-side stop.
	At intersections with multi-phase signals or dual turn lanes; this removes buses from area of complicated traffic movements	Buses can take advantage of the gaps in traffic flow created at signalized intersections behind the stop	Can result in the bus stopping twice; at a red light and then at the far-side stop, which interferes with traffic and risks rear end collisions
Mid-Block Stop	Traffic or street/sidewalk conditions at intersection are not conducive to near or far-side stop	Customer waiting areas may experience less pedestrian congestion	Requires greatest amount of curb space for no-parking restrictions
	Customer traffic generators are located mid-block and/or adjacent intersections are too far apart	Minimizes sight line obstructions for vehicles and pedestrians	Encourages unsafe pedestrian crossing unless a crosswalk is provided
	A queue jump lane conflicts with a near side or a far side stop	Conflicts with intersection traffic minimized	Increases walking distance to intersection crossing

Placement of bus stops must also factor in bus stop types, which will vary depending on existing site conditions and operational parameters. Table 2.2 below summarizes the pros and cons of various bus stop design types, as illustrated in Figure 2.1.

Table 2.2: Comparative Analysis of Bus Stop Types

Type of Stop	Advantages	Disadvantages
Curb-side	<ul style="list-style-type: none"> - Is easy to relocate or adjust - Least costly; doesn't require curb line adjustment 	<ul style="list-style-type: none"> - May cause traffic queues behind stopped bus, depending on lane configuration - Sensitive to illegal parking obstructions
Bus Bay or Turnout	<ul style="list-style-type: none"> - Allows customers to board and alight out of the travel lane - Provides a protected area away from moving vehicles for both the stopped bus and the bus customers - Minimizes delay to through traffic 	<ul style="list-style-type: none"> - May be harder for bus operators to re-enter traffic, especially during peak periods/busy roadways - Is more expensive to install and/or relocate - Potentially reduces sidewalk width
Curb Extension or Bulb out	<ul style="list-style-type: none"> - Shorter stop reduces impact on parking - Decreases the walking distance (and time) for pedestrians crossing the street at crosswalk - Provides additional sidewalk area for bus customers and amenities - Reduces bus dwell time 	<ul style="list-style-type: none"> - More costly to install - May result in bus obstructing the travel lane
		-



Figure 2.1: Bus Stop Design Types*

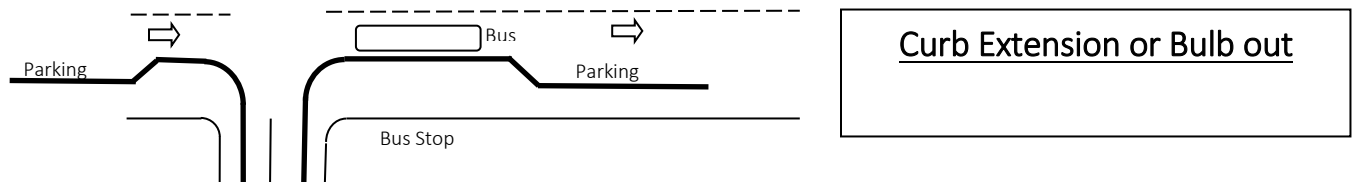
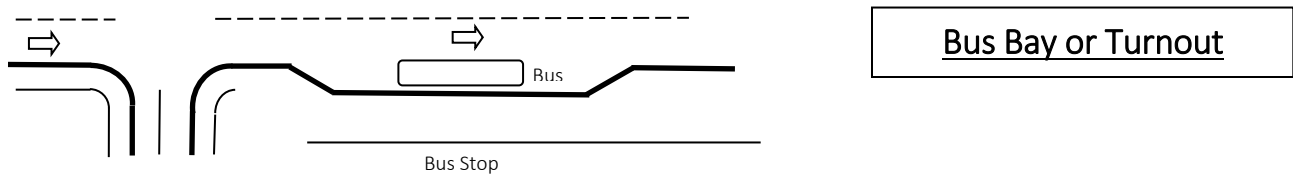
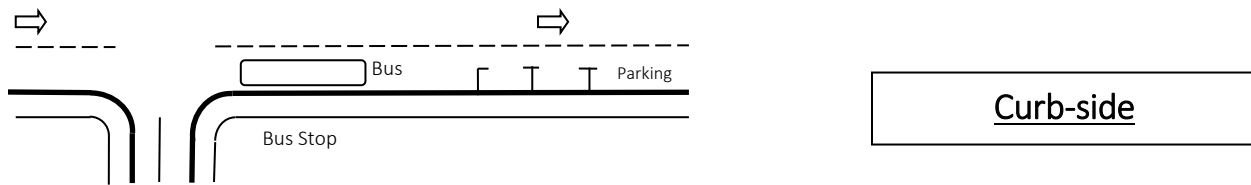

* Far-side stop conditions shown. Stops can also be mid-block or near-side.

Not to Scale

Customer Utilization

Bus stop placement shall be determined in part by the level of use by customers. Both boardings and alightings should be considered. For new stops, utilization levels must be weighed against impact on overall service and the fact that each new stop may add approximately 15 seconds on average to the overall trip time. Ridership data is routinely collected and updated by the MBTA. Data is captured by on-board ride checks or Automatic Passenger Counters (APCs), and is available upon request from MBTA's Service Planning Department.

In instances where existing bus stop placement is being reviewed, and removal and/or consolidation is being considered, customer utilization is a major determinant. Bus stops that have weekday combined boardings and alightings of less than 20% of the entire route's average weekday combined usage would be likely candidates for removal or relocation. All other stops would be reviewed for potential removal and/or consolidation with nearby stops. More discussion about bus stop consolidation is contained in Chapter 3. The following table provides an example of how the stop utilization analysis is performed.

Stop	Boardings & Alightings*	Boardings & Alightings for Route**	% of Total	Status
A	50	200	25%	Elimination generally not recommended
B	30		15%	Recommend relocation or elimination

*Average weekday combined boardings and alightings for all buses serving particular stop

**The average combined boardings and alightings for all stops on the route

Adjacent Land Use and Activities

To minimize walking distances, locate stops adjacent to major generators (large residential development, retail centers, education centers, local/state/federal government offices etc.) and near sensitive land uses such as elderly/public housing, medical facilities, or senior centers. Customers with reduced mobility are more likely to be able to use fixed-route transit if a bus stop is located in close proximity.

Compatibility with Adjacent Properties

As much as possible, avoid locating a bus stop immediately adjacent to land uses that are sensitive to the effects of parking loss, noise, and waiting customers. Residents may object to the presence of a bus stop in front of their home, especially if the stop is used for layovers. Efforts should be made to minimize the impact to each property owner. However, an individual property owner's perceived impacts should be viewed within the larger goal of maximizing access to bus services.

Safety

Locate bus stops close to crosswalks to encourage safe pedestrian crossings. Be sure that a stopped bus will neither block a crosswalk nor obstruct pedestrian visibility of oncoming traffic. It is generally safer to locate the bus stop on the far-side of a crosswalk, so that customers will cross behind, rather than in front of the bus.

Other curbside safety and accessibility considerations include:

- proximity of storm drains and catch basins, which put customers at risk of catching a foot or stumbling, or dropping their fare or pass
- uneven surfaces, such as tree grates and broken sidewalks, which could result in a fall
- surface traction (for example, stone aggregate can be exceedingly slippery when wet for persons using wheelchairs)
- water accumulation areas, which can also result in muddy and slippery surfaces,
- overgrown bushes, which may impede visibility and present a security issue. This situation may also result in obstructed sidewalks that could result in pedestrians walking in the street
- To the extent feasible, locate bus stops so that they don't block bicycle travel lanes.



Tree Grate Tripping Hazard



Broken Sidewalk at Boarding Area

The sightlines at the stop must be adequate to allow a bus to safely approach the stop, board and alight customers, and pull back into the travel lane. Obstructions can include trees, signs, buildings, shelters, topography, etc. Bus stops should not be located over the crest of a hill, immediately after a road curve to the right, or at other locations that might prevent oncoming traffic from seeing a stopped bus. If the bus has to stop in the travel lane, it is in danger of being struck from the rear. Even if the bus pulls out of the travel lane, pulling back into the travel lane presents accident potential. If a bus stop must be located at such a location, approaching vehicles should be warned of the need to be prepared to stop.

Accessibility

Bus stops should be located at sidewalks with curbs to facilitate accessible and safe boarding and alighting. Pathways to/from a bus stop should be on a level, firm and slip-resistant surface, free of obstacles, and in accordance with all applicable accessibility standards. Dirt, grass, and gravel surfaces are not acceptable for bus stops and landing pads. Near-side and far-side bus stops are generally easier to access due to their proximity to crosswalks as opposed to mid-block stops. The bus stop zone also needs to be long enough to enable a bus to pull parallel to the curb and for all bus doors to be adjacent to the curb. Sufficient curb length is determined by the location of the bus stop and the length of the bus serving the bus stop (see Chapter 4). Additional requirements for bus stop accessibility are provided in Chapter 5.

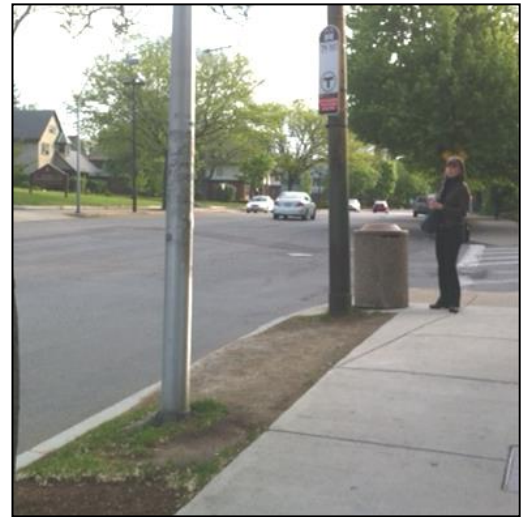

Bus Stops without Accessible Landing Pads and Boarding Areas

Intersection Operational Impacts

A poorly located bus stop can negatively impact the level of service at which an intersection functions. The most common occurrence of this is when blockage of traffic occurs by a bus servicing a near side stop. Unique characteristics, such as intersection angles, restricted turning lanes, traffic controls, and locations of driveways and crosswalks may influence the appropriate placement of a bus stop.

Lighting

Adequate lighting is important for customer comfort and security as well as to enable bus operators and traffic to see waiting customers. Bus stops should be located where they will be illuminated, preferably from an overhead street light.

Driveways

Buses serving a stop should not obstruct driveway access. For stops placed at a driveway, care should be taken to ensure that all bus doors align with level sidewalk areas before or after the driveway and not at sloped surfaces that may get slippery. For low volume driveways, temporary blockages are generally acceptable but must be considered on a site by site basis. A driveway within the bus stop zone can often be advantageous since it can effectively reduce the required bus stop length and thus reduce the need to displace on-street parking spaces. This is only advisable when the driveway isn't busy.

- Keep at least one driveway open to vehicles accessing the property while a bus is serving customers. When there are two driveways to a parcel on the same street, the downstream driveway should be blocked forcing vehicles to turn behind the bus to access the driveway.
- It is preferable to fully rather than partially block a driveway to prevent vehicles from attempting to squeeze by the bus in a situation with reduced sight distance.
- Locate bus stops to allow good visibility for vehicles leaving the property and to minimize vehicle/bus conflicts. This is best accomplished by placing bus stops where driveways are behind the stopped bus.

Bus Stops and Parking

Buses often compete for curbside space with street parking. This is an especially sensitive issue in front of businesses that value curbside parking. The longer the bus stop zone, the more parking spaces are potentially impacted. (U.S. data that shows businesses generally find proximity to transit as being more valuable than 2-4 parking spaces that may not turnover all day). Locating stop pull-in and pull-out zones to overlap with fire hydrants, crosswalks and driveways are ways of minimizing parking loss.



Many existing bus stops are not long enough to enable buses to align fully parallel to the curb. Proper alignment is necessary to provide safe and convenient access at all bus doors. Locating a bus stop in an area with existing curbside parking may require removal of enough parking to permit the bus to pull in, service the stop, and pull out/re-enter the travel lane. Another option is to install a curb extension or bus bulb out (see Chapter 9).

Blocked Bus Stop

Substandard bus stop lengths generally result in the bus partially obstructing the adjacent roadway travel lane and/or bike lane when servicing a stop. Customers may have to step into the street and maneuver between parked vehicles when entering or exiting the bus, which is a safety concern and poses an extreme challenge for customers with limited mobility.

Various measures should be incorporated into the bus stop design to help ensure that the bus can access the stop. Painted pavement markings and “No Parking” regulatory signs should be placed when parking could impact bus operations. Obstructed bus stops could impact bus operations, traffic movement, safe sight distance, and customer accessibility.

Right-of-Way Considerations

If a bus stop may be a candidate for a shelter or bench, a site should be selected that includes adequate right-of-way for constructing said improvements. Stops should be located and constructed to make use of existing sidewalks, or new sidewalks should be constructed to provide pedestrian access to the bus stop. At stops with heavy ridership, additional customer waiting/standing areas should be constructed off of the main sidewalk so that waiting customers do not block passage of other pedestrians. Curb extensions or bus nubs typically satisfy this need (see Chapter 9).

Eliminating or Relocating Bus Stops

Such actions must be reviewed and approved by the MBTA Service Planning Department and/or other operating entity. Relocation guidelines can be found in Chapter 2. Issues related to Accessibility and ADA compliance are discussed in Chapter 4.

Figure 2.2: Typical Bus Stop and Parking Interfaces

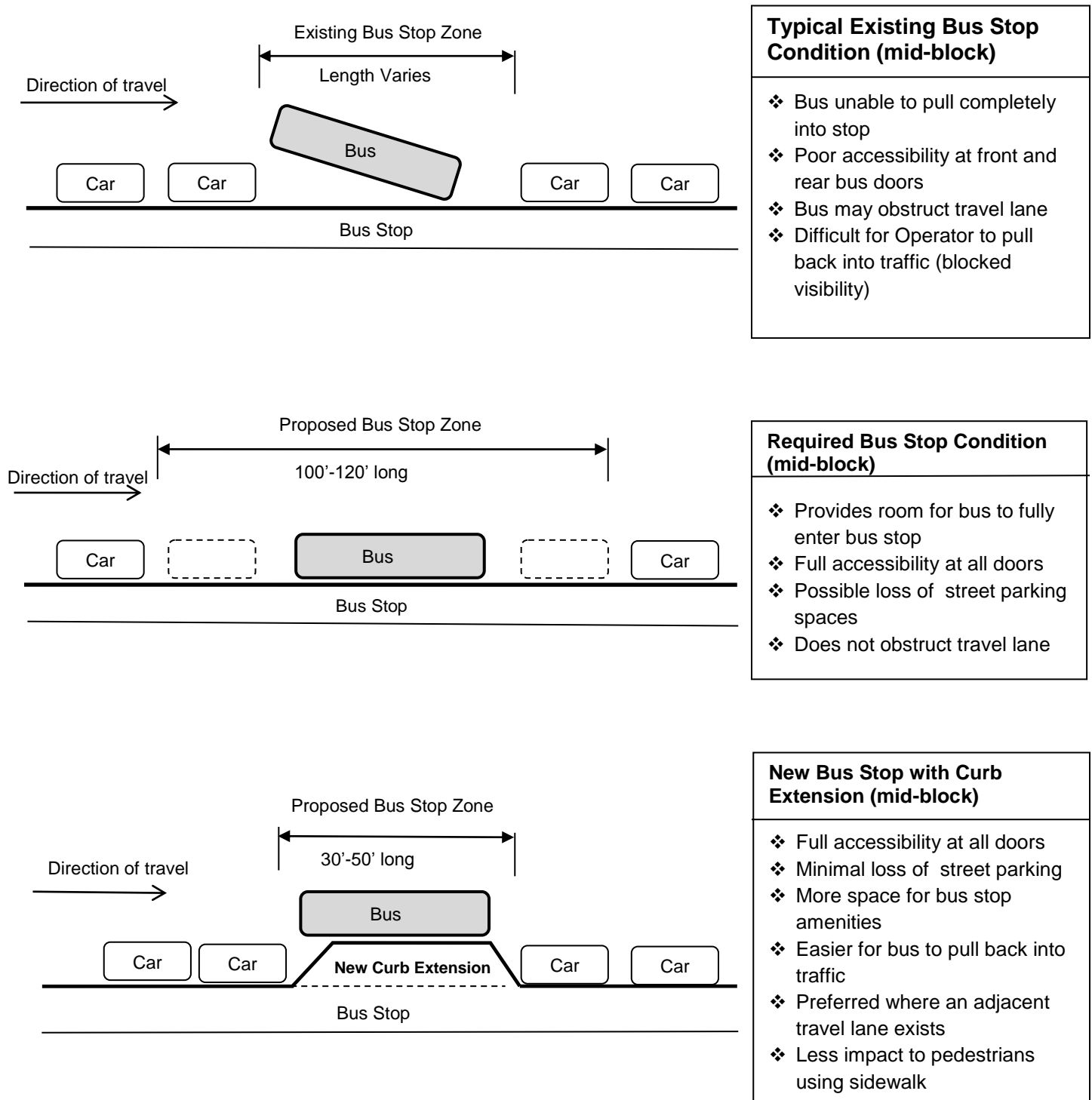

Consistency/Pairing

Stops should be located as close as possible to intersections so as to provide predictability for both bus operators and customers. This also enables the stop to have a name referenced by a cross street as opposed to a street number. Stops should generally be provided with a reciprocal or paired stop in the opposite direction so that customers will know where to get on the bus for their return trip.

Standardization

One of the most critical factors in the street-side design and placement of a bus stop involves standardization or consistency. Standardization is desirable because it results in less confusion for bus operators, customers, and motorists. Consistency in design however can be difficult to achieve since traffic, parking loss, turning volume, community preference, and political concerns can influence the decisions.

Traffic Signals and Signs

Bus stops should be located so that buses do not restrict visibility of traffic signals and signs by other vehicles. Because all bus customers become pedestrians upon leaving the bus, pedestrian signal indicators should be provided at nearby signalized intersections.

Bus Priority Measures

To facilitate improved bus service, stop positioning must factor in opportunities for Transit Signal Priority (TSP), Queue Jump Lanes (see Chapter 11) and curb extensions (see Chapter 9). This often factors into the decision to place the stop near-side or far-side.

3. BUS STOP SPACING

Bus stop spacing must balance reasonable bus trip times and customer walk distances. Closely-spaced stops mean shorter walk distances, but more frequent stops – and longer trip times. Longer stop spacing means less frequent stops and shorter travel times, but longer walk distances. There are many opportunities on most MBTA bus routes to adjust stop spacing to both better serve customers and reduce bus stop and service impacts to the community. Experience has shown that on most bus routes, 10-20% of the stops are too closely spaced. The pros and cons of increasing bus stop spacing are as follows:

Advantages:

- An accessible bus stop potentially displaces multiple on street parking spaces. Up to 7 parking spaces can get displaced for a 120' long space. Longer stop spacing results in fewer stops and reduced parking impact.
- It takes 15 seconds on average for a bus to serve a stop. Greater spacing and fewer stops shortens trip times and improves reliability
- Fewer and more widely spaced bus stops result in less potential interference with existing vehicular traffic that is impacted by buses pulling into and out of bus stops.
- Each bus stop creates an area of increased risk for pedestrians and cyclists-especially at crosswalks and bike lanes
- Fewer bus stops creates a better experience for customers in that there is less customer jostling as a result of boarding/alighting, and there's a reduced "Stop & Go" dynamic that creates the perception that the bus is traveling slowly

Disadvantages:

- Bus customers may have to walk further to access bus service. Having to walk say an additional 200 feet increases the walk time by approximately one minute.
- Customers get accustomed to bus stop locations and may be opposed to any sort of change.
- Longer travel distances may create hardship for seniors and persons with disabilities who are more likely to encounter path of travel barriers. This has an increased impact where there are hospitals, senior housing, medical facilities, etc.
- Increasing stop spacing may include stop relocations and/or alterations that will require additional accessibility improvements that could be difficult to implement.

The impact on parking has many variables. Making an existing bus stop accessible often requires the displacement of several parking spaces. When evaluating stop elimination and the benefits to street parking, the length of an accessible bus stop should be considered-not the length of an existing inaccessible stop.

The travel time impact created by each bus stop is affected by the number of boardings, obstructed bus stops, and high volumes of roadway traffic (making it difficult for bus to reenter traffic flow). A 15 second average delay is an industry-wide standard and typically applies to relatively high density urban settings.

Bus accidents involving bicycles and pedestrians are common. Buses serving a bus stop typically have to cross over the bike lane to get to the curb, creating a dangerous conflict point. Customers entering/exiting a bus will often suddenly run in front of a bus just pulling into or out of a bus stop

The MBTA’s spacing guidelines presented in Table 3.1 below were developed based on review of research studies on the optimal spacing of bus stops, bus stop spacing standards at other transit agencies, and feedback from the public, municipalities, and other stakeholders. Exceptions can be made to these guidelines. However, the average spacing along any route or route segment should fall within these guidelines.

When establishing spacing, it’s important to try to maintain paired stops (i.e. the inbound stop is at the same location or opposite the outbound stop)

Table 3.1: Bus Stop Spacing Guidelines

Bus Operating Environment	Average # of Stops per Mile	Average Distance Between Stops
Central Business District (CBD)	4-5	1,000-1,300 feet
Urban outside CBD and Key Bus Routes	4-7	750-1,300 feet
Suburban	4-5	1,000-1,300 feet
Bus Rapid Transit/Limited Stop Service	2-4	1,300-2,600 feet

Land uses located within approximately 1,000 feet of a bus corridor should be factored in when deciding on spacing and may necessitate more closely spaced stops in the immediate area. These include Education Centers, Employment Centers, Residential complexes, Retail Centers, and medical facilities with out-patient care

Spacing should also be sensitive to concentrations of seniors and persons with disabilities and where they live and travel.

When evaluating the potential impacts of increased distance between stops, the actual increase in walk time is often a consideration. It’s assumed that the average person walks 3-3.5 feet per second. MUTCD and US Access Board data generally assumes 2.5-3 feet per second for seniors. For every additional 100’ that a customer has to walk, the added walk time is just under 35-40 seconds.

Bus Stop Consolidation

It’s not uncommon for a bus route to have an excessive number of bus stops and/or stops that are too closely spaced. Through a process of stop eliminations and/or stop relocations, a more uniform and efficient stop layout can be established. Customer utilization and spacing of existing stops are the primary determining factors to consider although other factors must also be considered, as discussed in Chapter 2.

Aside from improved spacing, consolidation also has other benefits. Fewer stops mean shorter trip times. On average, it takes 15 seconds for a bus to serve a stop. This includes decelerating,



boarding/alighting, and then waiting for a gap to re-enter the travel lane. This time can vary widely depending on many factors; however 15 seconds is a good average for planning purposes.

What follows is an example of a typical stop consolidation analysis. The route segment being analyzed is shown on Figure 3.1. Stop data is shown on Table 3.2. Four existing eastbound bus stops (#2251-4) are relatively closely spaced. The average distance between these stops is 740'. Both #2252 and #2253 have relatively low usage AND they are closer to #2251 and #2254 than the MBTA's recommended standard spacing minimum (750') for an urban area or a Key Bus Route.

The average stop usage (boardings + alightings) for the entire route is 150. As recommended in Chapter 2, if stop usage is less than 20% of the route average (in this case 20% of 150) then the stop should be considered for elimination. 20% of 150 is 30. Usage at Stops #2252 and #2253 is less than 30.

Based on the MBTA's spacing and utilization standards, stops #2252 and #2254 are eligible for elimination. However, by doing this, the spacing between the remaining stops becomes 1735' which exceeds the guideline maximum of 1300'. Therefore, a recommended proposal is to locate a new stop approximately midway between the two, at Quincy Street. This is also preferable as it provides a paired stop with stop # 2290.

Stop #2254 was also shifted to near-side because there was more space to install a shelter and the intersection isn't signalized.

Figure 3.1: Bus Stop Consolidation Example

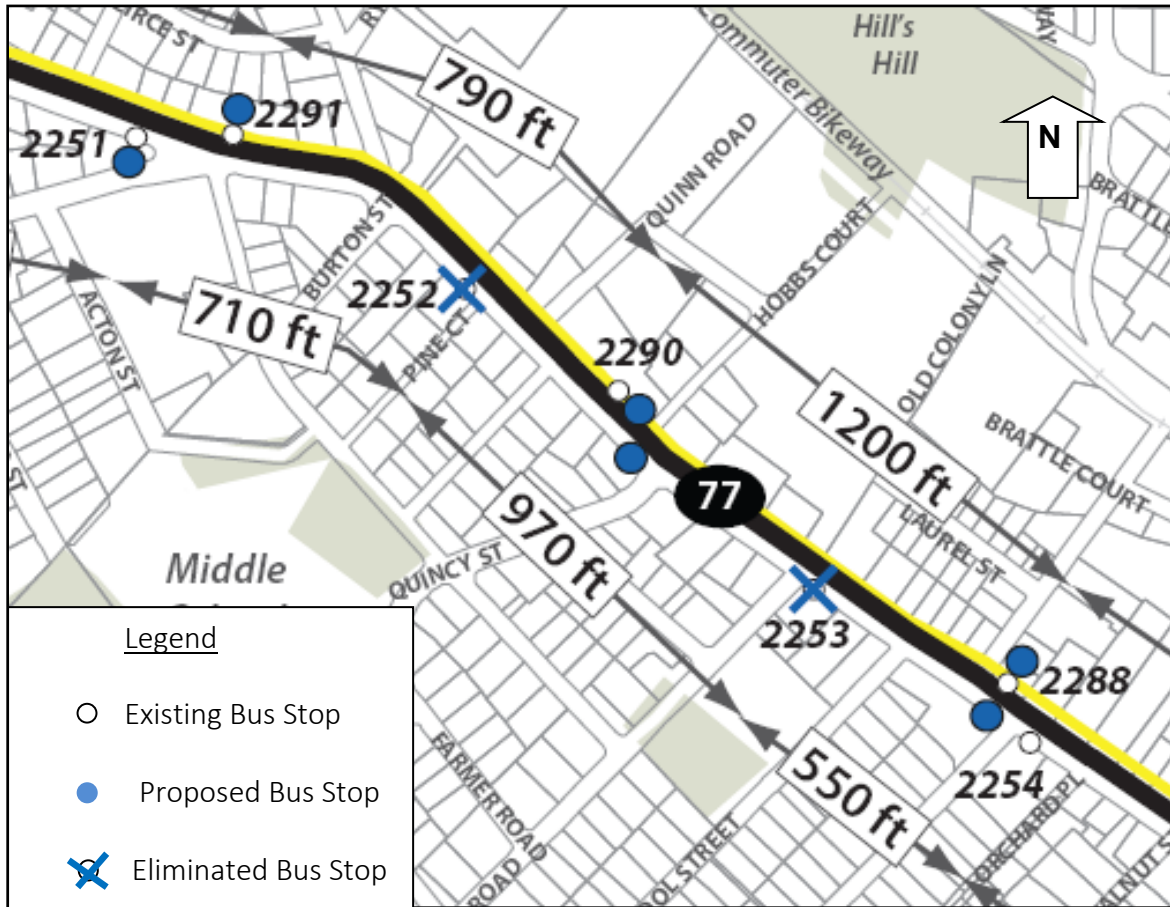

Table 3.2: Consolidation Example-Existing Conditions

Stop ID #	Distance Between Stops	Less Than The Minimum Spacing of 750'?	Stop Usage (Boardings + Alightings)	Exceeds 20% of The Route's Average Usage?
2251			75	Yes
	710'	Yes		
2252			25	No
	970'	No		
2253			15	No
	550'	Yes		
2254			110	Yes

Table 3.3: Consolidation Example- Proposed Conditions

Stop ID#	Distance Between Stops	Projected Stop Usage (Boardings + Alightings)
2251		87
	1195'	
2252 (relocated)		22
	1035'	
2254		117

The proposed distance between stops falls within the MBTA's standards. To determine if a stop is eligible for a shelter and/or a bench, the stop utilization (boardings) can be projected by assuming users of the removed stops will go to the next closest stops.

These are recommended guidelines only. Exceptions are often warranted on a case-by-case basis but must be approved by the MBTA. For example, if a stop elimination would require seniors and persons with disabilities to go to a nearby stop with a lesser level of accessibility, then the stop would likely not be eliminated even if it met other criteria for elimination.

4. BUS STOP LENGTH AND CONFIGURATION

Adequate space must be provided at a bus stop to ensure safety and accessibility. Space must be provided to enable a bus to maneuver around parked cars or other obstacles to enter the bus stop zone, and to re-enter the traffic stream upon exiting. Bus stop lengths should be sufficient to allow MBTA buses to come to a stop parallel to the curb with all doors no more than 6-12" from the curb or designated boarding area. This facilitates usage of the bus front door access ramp and maximizes bus accessibility and safety at all doors.



Bus Back Door Not Aligned With Curb

The bus stop length should be sufficient to accommodate the largest bus likely to be used on the route served. To determine which types of buses will be operating on a particular route, contact the MBTA Service Planning Department. A bus stop that is designed to serve 60' buses must also be capable of serving 40' buses.

MBTA buses operate in a variety of environments including highways, parkways, bus lanes, streets with and without parking, and streets with bicycle lanes. Each environment may impact the space necessary for a bus to safely access the stop. The criteria below are for buses operating in mixed traffic where buses must maneuver in and out of traffic as well as around parked cars and other obstacles, typically increasing the clearance needed along the curb. In other operating environments, bus stop lengths can be adjusted accordingly to meet the design objective.

For bus stops where more than one bus may be stopped at any given time or more than one route serves the same stop, additional curb space may be needed. A general rule of thumb is to add one bus length plus 10' for each additional bus to be accommodated. The decision to provide berthing space for more than one bus depends on service frequency, usage as a layover, and roadway width. Given the wide range of variable and service levels, all questions related to number of berths required should be reviewed by the MBTA Service Planning Department.

Based on the considerations listed above, the standards outlined in Table 4.1 are to be used to establish the length of all bus stops. These required lengths are also displayed in plan view in Figures 4.2 – 4.5.

Table 4.1: Bus Stop Lengths

Stop Placement	40' Bus		60' Bus	
	Standard [1]	Minimum [2]	Standard [1]	Minimum [2]
Curb Extension/ Bulb out	50'	40'	70'	60'
Near-side	100'	90'	120'	110'
Far-side [3]	80'	60'	100'	80'
Mid-block [3]	12'	100'	140'	120'

[1] Standard dimensions should always be used where feasible. They are especially crucial along roadways with high traffic volumes and stops with high boardings and alightings.

[2] The minimum dimensions should only be used when the standard dimensions aren't feasible. They should only be used at low speed roadways and at low volume bus stops. In situations where providing even the minimum bus stop length is not allowed by the controlling entity, the length may be reduced contingent on approval by the MBTA. However, the stop length must be sufficient to enable at least the front door to be 6-12" from the curb in order to facilitate access ramp deployment.

[3] Dimension can be reduced by 7' if there is no obstruction (parking space etc.) directly in front of the bus stop.

All the bus stop lengths allow the bus to pull fully into the stop without having to significantly overhang the curb. If existing features such as light poles, signs, walls, etc. are located closer than 12" to the curb line, then the bus stop zone may need to be lengthened to give the bus additional maneuvering space.

If a bus stop zone is too short and the bus operator is unable to bring all doors to within 6-12" of the curb, undesirable conditions are created. As the distance between the bus and the curb increases, customers will likely have to board from street level instead of sidewalk level, impairing safety and accessibility. If a bus "angles in" or "nose dives", the back of the bus may extend into the adjacent travel lane and obstruct traffic. The bus operator may also have difficulty reentering traffic since his/her rear view of traffic may be blocked by the back of the bus. This also creates a dangerous situation for cyclists.

Wherever possible, curb extensions should be considered. Providing a curb extension reduces the required bus stop length by effectively eliminating or reducing the space needed for the bus to pull into and out of a bus stop (see Figure 2.2 in Chapter 2). The bus is able to serve the bus stop without fully leaving the travel lane. See Chapter 9 for additional discussion regarding curb extensions.

Other street features can also reduce length requirements. Driveways, crosswalks, loading zones and fire hydrants already result in curbside space that cannot be obstructed by parked cars. This space can be used for buses as they pull into or out of a bus stop. As an example, see Figure 4.1 below. Since the

driveway and/or fire hydrant will always be unobstructed by parked cars, the bus can use that space to pull into the bus stop.

Figure 4.1: Near-Side Bus Stop Adjacent to a Driveway

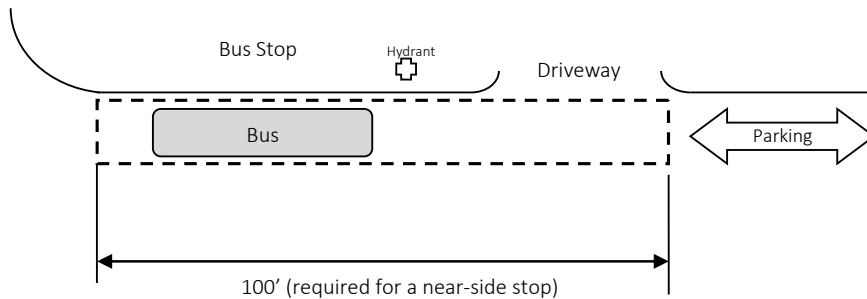

Bus Stop Configuration

The required bus stop length may be influenced by existing curbside features and by the exact location within the bus stop zone that the bus will stop. The front and rear doors must both align with the curb and accommodate an accessible path of travel to the sidewalk.

One of the primary functions of the bus stop signs (see Chapter 8) is to delineate the limits of the stop. This helps the bus operator properly align the bus within the stop zone to facilitate accessible boarding.

Bus Operators are trained to stop 10' short of a potential obstruction at the head end of the stop, such as a parked vehicle, in order to allow room to pull back into traffic. If a front obstruction doesn't exist, operators are trained to stop 3'-5' from the front sign. Variations in site conditions may require operator judgment.

The locations and spacing of the landing pads and rear door clear zones are dependent on bus type and stop locations (See Figures 4.2-4.5). Landing pads are discussed in more detail in Chapter 5.

The rear door clear zones are specified to assist with the design of stop positioning when there are sidewalk obstructions. It is preferable to maintain a continuous 4' wide clear zone along the entire length of the bus stop to provide maximum flexibility. The bus will often be unable to stop in a precise location due to conditions out of the bus operator's control. (Illegal parking, etc.)

Figure 4.2: Far-Side Bus Stop

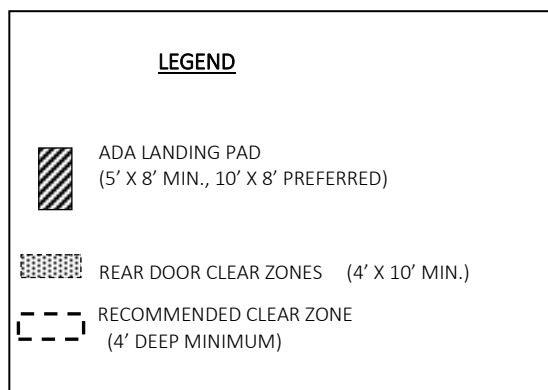
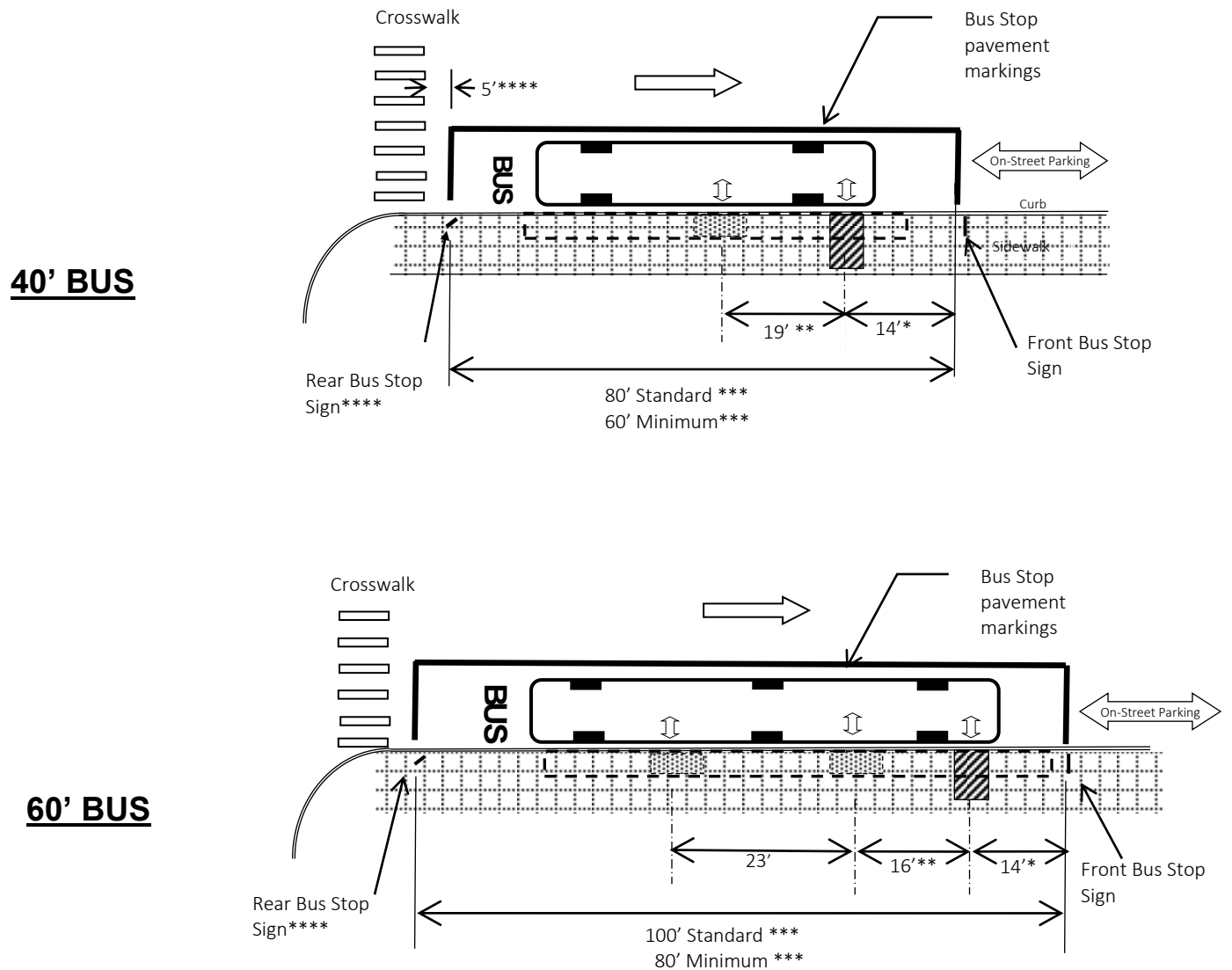

- * Reduce to 7' if there isn't parking or another obstruction directly in front of bus stop.
- ** Increase to 22' for stops serving Electric Trolley Buses
- *** Reduce by 7' if there isn't parking or another obstruction directly in front of bus stop.
- **** If no crosswalk, then set at curb point of curvature.

Figure 4.3: Near-Side Bus Stop

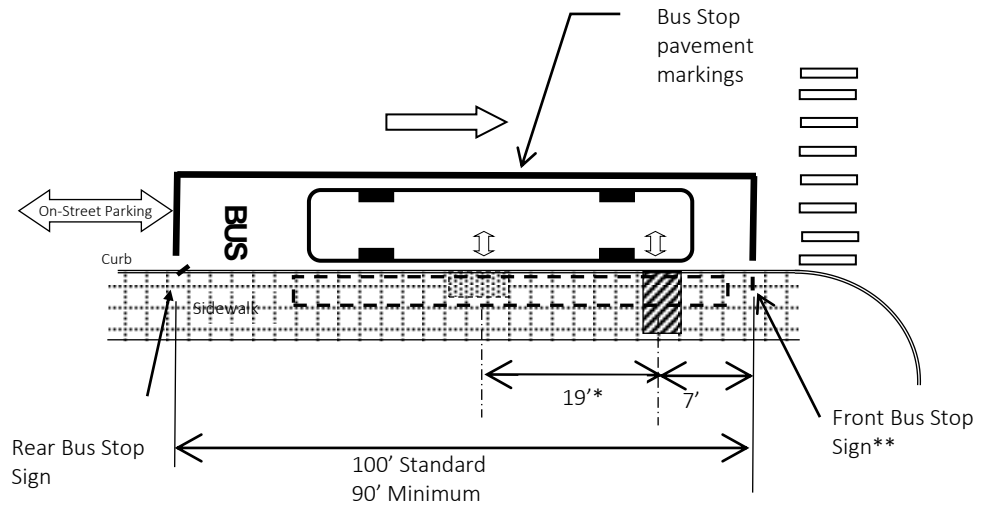

40' BUS

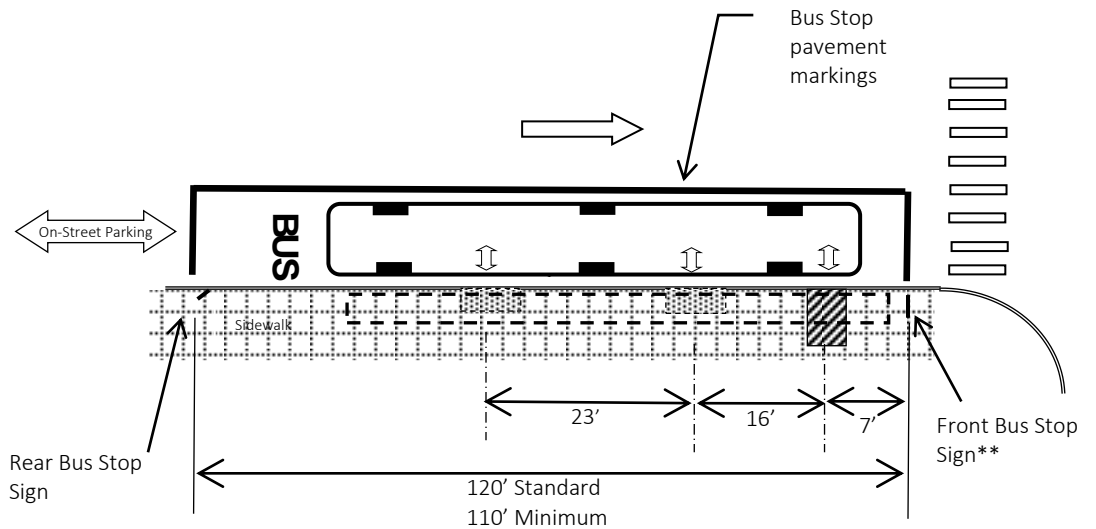

60' BUS



LEGEND

-  ADA LANDING PAD (5'X8' MIN., 10'X8' PREFERRED)
-  REAR DOOR CLEAR ZONES (4' X 10' MIN.)
-  RECOMMENDED CLEAR ZONE (4' DEEP MINIMUM)

* Increase to 22' for stops serving Electric Trolley Buses

** Where applicable, set at stop line, or 5' back from crosswalk- whichever is greater

Figure 4.4: Mid-Block Bus Stop

40' BUS

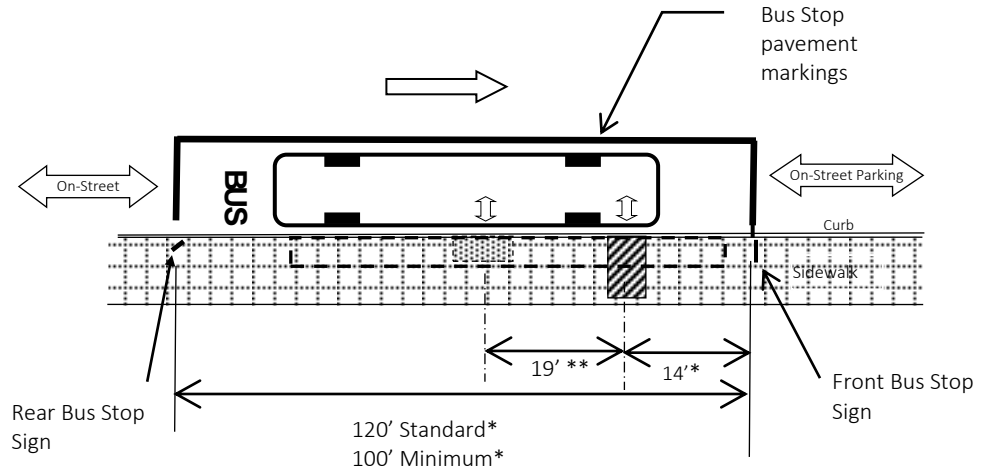

60' BUS

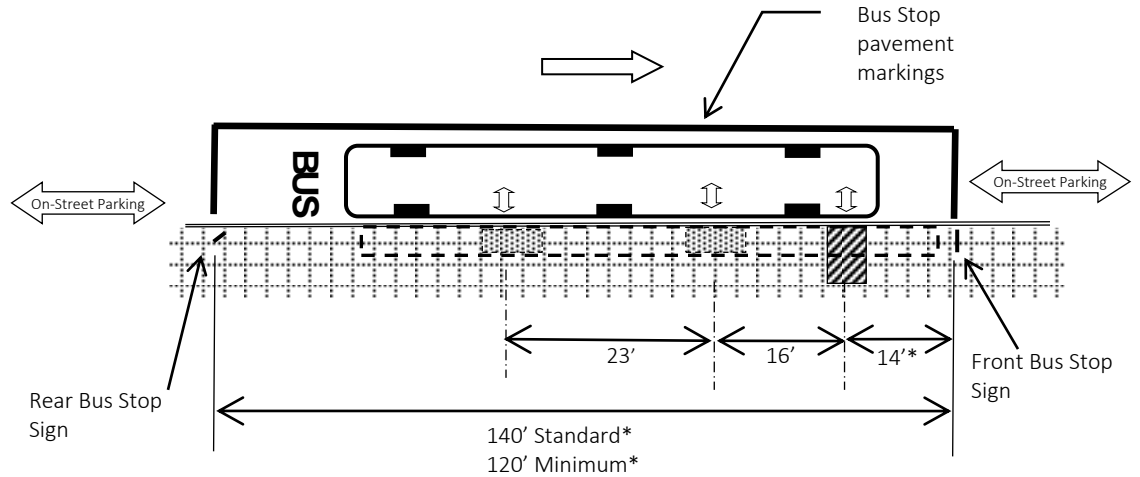

LEGEND

ADA LANDING PAD (5'X8' MIN., 10'X8' PREFERRED)

REAR DOOR CLEAR ZONES (4' X 10' MIN.)

RECOMMENDED CLEAR ZONE (4' DEEP MINIMUM)

* Reduce by 7' if there isn't parking or another obstruction directly in front of bus stop.

** Increase to 22' for stops serving Electric Trolley Buses

5. BUS STOP ACCESSIBILITY & SIDEWALK ENVIRONMENT

All MBTA bus stops must be functional, safe, accessible and comfortable to all users, including seniors and persons with disabilities. Since the majority of the MBTA's bus routes service bus stops located on or adjacent to sidewalks, awareness of the sidewalk environment is crucial towards achieving this goal. Although a bus stop has several interfacing physical elements, this Chapter focuses on the bus stop sidewalk environment. Bus stop placement and lengths are discussed in Chapters 2 and 4. Bus stop amenities are discussed in Chapter 6.



Inaccessible Bus Stop

Accessibility Requirements

Any project that involves the construction, movement or alteration of a bus stop must comply with the following accessibility regulations and standards:

- US DOT ADA Regulations: The MBTA has a broad, statutory obligation under the *Americans with Disabilities Act (ADA)* to insure that its bus service is accessible to individuals with disabilities. (*ADA Accessible Design Standards-2004*, as adopted by US DOT in 2006)
- Massachusetts Architectural Access Board (MAAB): The 2006 *Rules and Regulations of the Massachusetts Architectural Access Board (521 CMR)* do not include specific standards for bus stops or shelters; the transportation section only addresses bus *stations* and *platforms*. 521 CMR does cover certain elements of bus stops, including accessible path of travel, benches, curb ramps, protruding objects, sidewalks and walkways.
- BCIL Settlement Agreement: In 2006, the MBTA entered into a settlement agreement with the Boston Center for Independent Living (BCIL) that requires the MBTA to provide accessible bus service and to work closely with municipalities to insure that access to bus stops is reliable.
- MBTA Requirements: The MBTA has adopted additional requirements based on our experience and the unique characteristics of bus service.

To best understand and describe the MBTA's bus stop accessibility requirements, it's helpful to think of the bus stop environment as several distinct components as described below:

Figure 5.1: Bus Stop Accessibility Component Diagram

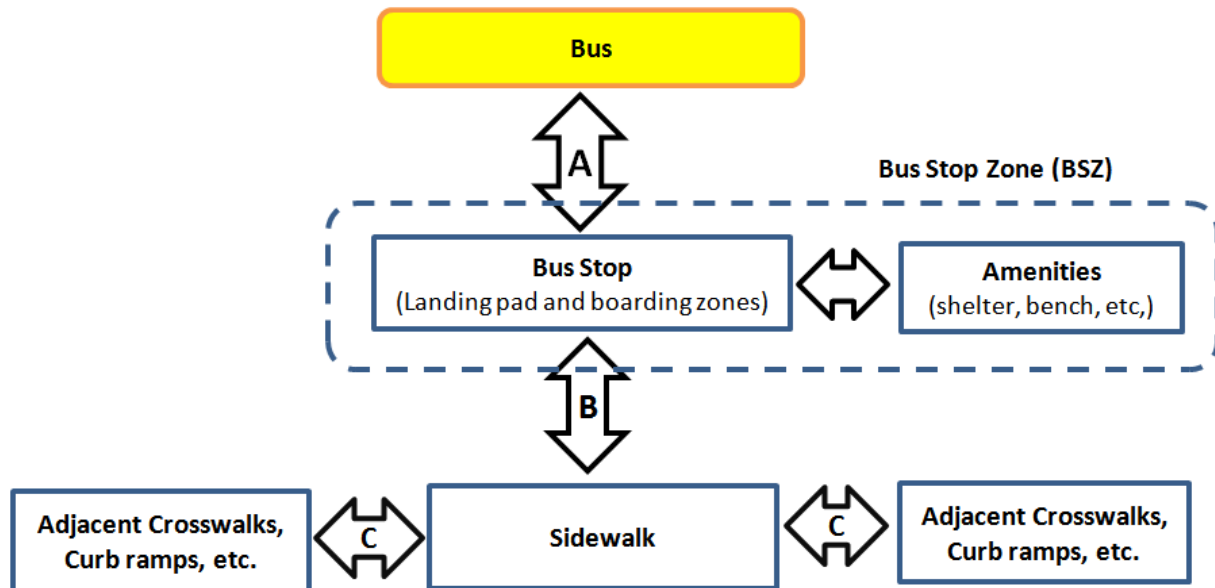

Bus-to-Bus Stop connectivity (Link A above) is vital for customer safety and accessibility. This occurs at the front and rear bus doors and the goal is to minimize the customer step distance—both horizontally and vertically. A bus operator is required to align both bus doors to within 6 to 12” of the sidewalk curb. At sidewalk locations this results in a vertical step of approximately 8”. If the bus is unable to get close to the curb, customers are faced with a 14” vertical step. Additionally, the deployed bus access ramp will have an unacceptable running slope. To establish an accessible path of travel (POT), the bus operator must align the bus parallel and adjacent to the curb, with the bus front door aligned with the designated sidewalk landing pad, and in close proximity to the bus stop sign.

The Bus Stop Zone (BSZ) is the area where customers wait for, board and alight a bus. Dimensionally, it typically extends for the length of a bus and the width of the sidewalk. At a minimum, the BSZ must include an accessible landing pad (described below). For new or altered bus stops, an accessible path of travel must be provided between the landing pad, the adjacent sidewalk and bus stop amenities such as shelters and benches.

The bus stop boarding and alighting area at the bus front door is referred to as the landing pad. An accessible landing pad must be provided at every new, relocated or altered bus stop.



Deployed Bus Access Ramp

An accessible path of travel (POT) is defined as a 4' wide¹, stable, firm and slip resistant pathway (generally concrete or asphalt), clear of obstructions, with a cross slope not exceeding 2% and a running slope not exceeding the slope of the adjacent roadway and preferably not more than 5%.

A POT must be provided between the landing pad, bus stop zone and the adjacent sidewalk (Link B). In most cases, the landing pad is already part of the sidewalk so there isn't an issue (see Figure 5.2). However, if there is a grass strip, then a POT would have to be provided across the grass strip to the sidewalk.



Accessible Bus Stop Zone



Bus stop Without Accessible Landing Pad or POT

A POT must be provided between the bus stop and the landing pad and the closest adjacent crosswalk and/or street crossing (Link C). This POT must include curb ramps on either end of the crossing. The POT must follow a smooth surface clear of obstructions and be at least 4 feet wide. If the POT follows a newly constructed or altered sidewalk, then the cross slope should not exceed 2%. If the POT follows an existing sidewalk, then a maximum cross slope of 4% is permitted.

In most cases, this POT follows municipally owned sidewalks not under the MBTA's control and since these are outside of the bus stop zone, providing an accessible POT traversing these areas is also the responsibility of the controlling municipality or agency. If the entity in control of the sidewalk, curb ramps and crosswalks plans to make this POT accessible within the next 3-5 years, then these access improvements (Link C only) may be deferred by the MBTA.

Figure 5.2 shows a typical bus stop and the required interconnectivity of various bus stop elements to achieve full accessibility.

¹ In certain situations, where approved by the MBTA, this may be reduced to 36".

New Construction and Alterations

Bus stop accessibility requirements vary depending on the scope of work. The extent of required accessibility features vary depending on the level and degree of proposed alterations.

The construction of new bus stops must fully comply with all applicable accessibility regulations. However, the alteration of certain bus stop elements trigger more particular obligations, as indicated on Table 5.1 below.

Table 5.1: Scope of Work and Accessibility Requirements

Scope of Work	Accessibility Requirements Triggered			
	Adequate Bus Stop Length (See Chapter 4)	Accessible Landing Pad	Accessible Path Of Travel To The Sidewalk	Path Of Travel To And Across Closest Street
Create new stop or move stop to a new location [1]	X	X	X	X
New shelter	X	X	X	
New bench				
Lengthen bus stop		X [3]	X [3]	
Install/move bus stop sign [2]	X			
New bus stop pavement markings	X			
New sidewalk or curb at a bus stop	X	X	X	
New bus stop curb extension	X	X	X	X

[1] This also includes situations where a bus stop is eliminated. The next closest stop must provide access that is at least as good as the eliminated stop

[2] Does not include replacement of an existing sign

[3] Only if lengthening requires moving the front bus stop sign

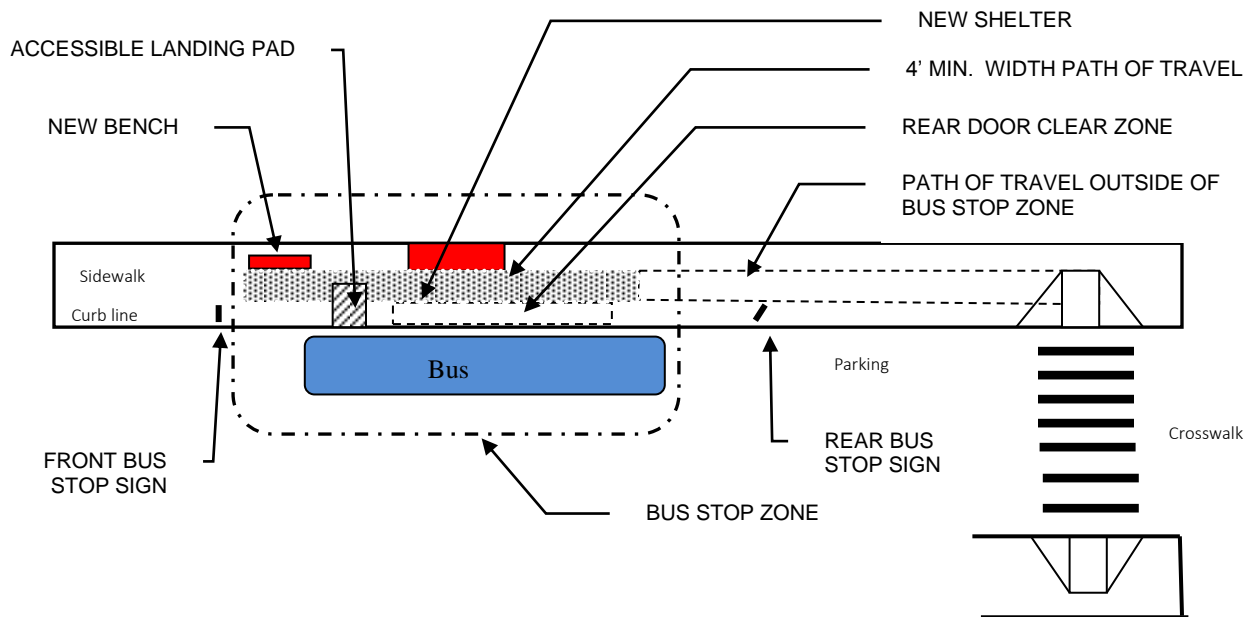
Figure 5.2: Bus Stop Accessibility Prototype

Accessible Landing Pad

All MBTA buses are equipped with a front door mechanical access ramp (36" wide) deployed by the operator on request. Fully deployed, it extends out 3' from the bus. A ramp or lift is not provided at the back door². To provide full accessibility, the ramp must be deployed onto a sidewalk landing pad at least 4" above the roadway surface. Deployment of the ramp directly onto the street creates an unacceptably steep and inaccessible POT.

A landing pad consists of a continuous, unobstructed zone contiguous to the curb and to the street. The minimum dimensions allow deployment of the access ramp and allow a customer in a wheelchair to board or alight the bus. Minimum dimensions consist of a clear zone 5' wide (parallel to the curb) by 8' long (perpendicular to the curb). At newly constructed sidewalks and where feasible, a 10' x 8' landing pad should be provided. If the sidewalk width is narrower than 8', the landing pad must be extended beyond the sidewalk to provide the minimum 8' length. If 8' is not achievable, the bus stop is not considered accessible and must be either closed or relocated.³

Avoid locating landing pads in front of building entrances and shelters wherever possible. Avoid locating rear door clear zones in front of shelters to avoid conflict between customers alighting and those leaving the shelter to board at the front door.

³ Under certain conditions, this requirement may be waived by the MBTA and/or the MAAB and USDOT

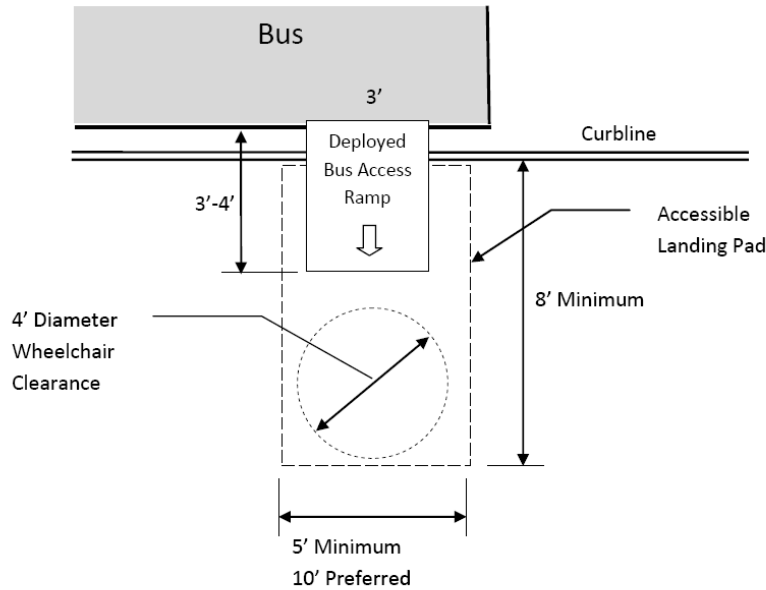
Figure 5.3: Accessible Landing Pad Detail

Note: All sidewalk width measurements shall be taken from the back of the curb-not the face. The top of curb cannot be counted as part of the path of travel.

The slope of the landing pad parallel to the roadway shall follow the roadway slope and preferably not exceed 5%. If 5% slope cannot be achieved due to the existing roadway profile/slope, then the landing pad slope must match the existing roadway to the maximum extent practicable. The cross slope perpendicular to the roadway shall not be steeper than 2%. No amenities including sign posts, shelters and benches, can be located within the landing pad limits.

Newly Constructed Accessible Landing Pad

Rear Door Clear Zones

To ensure that there is a path of travel at all rear bus doors, clear zones should be provided on the sidewalk that at a minimum, align with all rear bus doors of the stopped bus. To ensure that all bus types operating on the route have rear door access, a minimum 10' long x 4' deep clear zone should be provided at each door. Ideally, a contiguous 4' deep clear zone should extend from the front door landing pad to the back of the bus stop zone. Although not required, it is preferable for the clear zones to provide a cross slope not exceeding 2% (refer to Figure 5.2).

Landing Pad Delineation

Bus operators may have difficulty aligning the bus front door (and access ramp) with the designated landing pad. This is especially problematic if the landing pad is in close proximity to obstacles that could impede ramp deployment and an accessible path of travel- such as street furniture, signs, curb cuts, driveways, grass, etc. To help the operator achieve proper alignment, several options are available and are strongly recommended.

- The face and top of the curb at the landing pad area can be painted or otherwise marked to improve visibility (see Chapter 10).
- The Landing pad surface can be visually delineated. Options include colored concrete, paint, pavers etc.
- The landing pad can be made wider to provide a larger margin of error. For locations where proper alignment is critical, the landing pad should be 10' wide instead of the required 5'. This situation is most common at bus stops where the sidewalk is separated from the bus stop by a grass strip or other unpaved surface.

Pedestrian Connections/Path of Travel

To be fully accessible, the landing pad must be connected to a sidewalk of sufficient width and condition for a person in a wheelchair to use. An accessible POT is 4' wide. Curb cuts with slopes no steeper than 1:12 are needed where level changes occur (such as at a crosswalk). If items such as newspaper boxes, tree grates, utility poles, trash cans, and encroaching grass or bushes obstruct the POT, the sidewalk is not considered accessible. If necessary, a wider sidewalk must be provided to ensure that customers are able to get to and from the bus stop.



Inaccessible POT around Shelter

Curb Ramps

Curb ramps (also referred to a pedestrian ramps or curb cuts) are provided to allow entrance to the street surface and/or crosswalks. Curb ramps are an integral part of the pedestrian POT leading to and from bus stop locations. Ramps are to be designed to conform to state and federal Accessibility standards. At crosswalk locations, curb ramps must be provided at both ends of the crosswalk.

Pedestrian Street Crossings

Pedestrian crossings, including pedestrian ramps, shall comply with State and Federal accessibility requirements. At signalized pedestrian crossings, push buttons should be provided, and include a level area. The buttons shall have a tactile surface to assist the visually impaired and the signal when activated should have an audible sound. . The technical requirements for curb ramps and accessible pedestrian signals can be found in the US Access Board's Public Rights of Way Guidelines and MUTCD Chapter 4E. Municipalities are expected by US Department of Justice and Federal Highway to have up to date 504/ADA Transition Plans to remove non-compliant curbs, curb ramps, signals, and sidewalks.

Reciprocal Bus Stops

Anytime improvements are made to a bus stop, consideration must also be given to the reciprocal or paired bus stop (Presumably, a customer boarding the bus on one side of the street will want to disembark on the opposite side of the street.). An accessible path of travel should be provided between these two stops.

6. BUS STOP AMENITIES

The bus stop represents one of the MBTA's best marketing opportunities. A well designed and equipped bus stop improves operations, ridership and transit's value to the community. Certain customer amenities can play a significant role in attracting and retaining customers. Customer amenities are intended to improve customer comfort, as well as provide a sense of safety and security. These attributes can affect an individual's decision on whether or not to use transit. The following types of amenities can be provided at bus stops, depending on level of usage and/or type of service:



- Customer shelters
- Benches
- Trash & recycling receptacles
- Signs, schedules & maps
- Bus arrival information and electronic signage
- Bicycle parking facilities

The decision to install amenities at a particular stop takes into account a number of factors, including:

Customer Utilization - The level and type of customer usage plays a primary role in determining where amenities are warranted. Bus stop consolidation often results in customers having to walk further distances to access transit. In these cases, provision of certain amenities is desirable to in part offset any possible inconvenience.

Customer Transfer Activity - High transfer activity generally means that customers may have to wait for connections. Depending on characteristics of various connections, additional amenities should be considered.

Transit Corridor Marketing Efforts - Bus Rapid Transit (BRT) and Key Bus Route Improvements both benefit from enhanced marketing and branding and this is often provided through the provision of amenities.

Title VI, Environmental Justice and Community Equity - Amenities need to be evenly and fairly distributed amongst bus stops in both low income and minority communities, and meet the requirements of Title VI of the 1964 Civil Rights Act as defined in the FTA Circular C 4702.1. Title VI. Environmental Justice Principles mandate that MBTA services-including shelters and

amenities- are distributed in such a manner that minority and low income communities receive benefits in the same proportion as the total service area.

Proximity to Existing Sheltered Areas - New amenities may not be needed if customers are able to take advantage of existing facilities located at the bus stop. For example, an existing storefront canopy or awning could provide shelter for waiting customers and preclude the need for a new shelter.

Customer and Community Requests – Communities, organizations and individuals often make requests for amenities at specific stops-often reflecting specific needs such as proximity to elderly housing or medical facilities.

Installation and Maintenance Costs - The benefits offered by each type of amenity must be weighed against the cost of procurement, installation and maintenance. Although in certain instances the MBTA may carry the cost of purchasing and installing amenities, a Municipality or a third party may be asked to take on the responsibility for maintenance. Adopt-a-Stop programs are one option, to cover installation and/or maintenance costs.

Bus Stop Environment/Adjacent Land Use - The characteristics of the surrounding neighborhood may influence the type or design of bus stop amenities. For example, neighborhoods may require street furniture that is consistent with the overall design of the streetscape. Design should consider the needs of the local environment and incorporate community input.

General Installation Considerations

All bus stop amenities must meet all accessibility requirements (see Chapter 5). A minimum 4 feet wide path of travel must be maintained throughout the bus stop zone and street furniture and amenities must be kept clear of landing pads. Placement shall take into consideration other preexisting sidewalk amenities and features including tree grates, poles, etc., to create a POT that is barrier free, as straight as possible and one that minimizes the need for pedestrians to have to zigzag around obstacles. The following clearances should be maintained when located amenities:

Element	Clearance/Path of Travel	
	Minimum	Standard
Fire hydrants	4'	5'
Other street furniture	4'	5'
Building entrances	5'	10'
In-ground elements (manholes, tree grates, valve boxes etc.)	1'	3'
Building face or obstruction (wall, fence, etc.) - to facilitate building maintenance and trash removal.	6"	1'
Path of travel between bench and landing pad	4'	5'

Benches

Benches are the most common bus stop amenity and are generally the simplest and most desirable to provide, given their nominal cost and space requirements. Benches should be provided when any of the following conditions exist:

- The bus stop has at least 50 daily boardings
- The stop serves a significant number of seniors or persons with disabilities

Benches may also be warranted in the following situations:

- There is evidence of customers sitting on steps, walls etc. located on abutting private property
- The stop is located on a low frequency bus route



MBTA Bench Policy

The purpose of this policy is to provide guidance for the placement of benches at MBTA bus stops, stations and terminal facilities, and to establish a procedure for evaluating bench requests. In areas or locations where the MBTA, or its contractors, are the primary suppliers of benches at bus stops, placements will be evaluated using two steps:

- (1) Conformance with eligibility standards
- (2) Pass a site suitability test

Evaluation Procedure

The first step in the evaluation process is to determine if the bus stop conforms to bench eligibility standards. The number of boardings at a bus stop is a major determinant for eligibility. As described in the table below, all bus stops that meet the required number of boardings will be eligible. However, a number of other criteria can also be considered. To standardize the process, the various types of criteria have been given values. The following table lists all criteria to be factored into an assessment of eligibility for each bus stop and the value associated with each criterion. A site must receive a total of 70 points to be considered eligible under this policy.



Eligibility Criteria	Points
50+ Average weekday boardings (ADB)- all routes*	70
26-49 Average weekday boardings	50
5-25 Average weekday boardings	35
MBTA initiative to strengthen route or stop identity	20
Facilities for seniors, disabled, medical or social services in close proximity to stop	20

Passing Score: 70

*At stops with 150+ average weekday boardings, two benches should be provided where feasible (includes the bench in the shelter if applicable).

Any bus stop that has more than 50 boardings is automatically eligible for a bench. For bus stops with fewer boardings, a combination of the factors listed above will be considered in determining eligibility.

The second step in the evaluation process is the site suitability test. There are physical and practical requirements that must be met before a bench can be placed. These include:

- (1) Approval of property owner
- (2) Abutter and Municipal approval
- (3) Compliance with MBTA and ADA accessibility requirements
- (4) Adequate physical space
- (5) Proximity to actual bus stop zone

Title VI Reporting

The Service Planning Department retains the necessary documents to ensure correct application of the policy and also submits the required Title VI reports in conjunction with CTPS. Title VI ensures that MBTA services are distributed in such a manner that minority communities receive benefits in the same proportion as the total service area.

In terms of the bench policy, once a bus stop is eligible for a bench it will be included in all analyses for Title VI purposes, until such time that it is indicated otherwise. Consequently, all bus stops with 50 or more boardings will be included in Title VI reports, as well as any bus stops with less than 50 boardings that meet the 70-point eligibility requirement. Any bus stop that meets the eligibility standard, but is found not to meet the site suitability test, will be noted and not included in the analysis. Bus stops in the MBTA service area that have pre-existing benches, but do not meet the policy requirements, will be noted and included in the total comparisons.

When specifying benches, the following guidelines should be adhered to:

- Benches shall be durable, easy to maintain and resistant to weather conditions, graffiti, cutting, fire, and other forms of vandalism.
- At least 43" long and 20-24" wide
- Design shall be compatible with other street furniture.
- Seat height must be 17– 19" measured from ground level to the top of the seat surface.
- Provide armrests to assist individuals who may have difficulty sitting or standing.
- Provide mid-bench armrests or other features to discourage long term occupancy/reclining.
- Provide back support if there is no adjacent wall. Back support should extend from a point 2" maximum above the seat surface to a point at least 18" above the seat surface. Back support should be 2 ½" maximum from the rear edge of the seat measured horizontally.*
- Ensure benches are designed to prevent accumulation of water
- In hot, sunny climates, avoid materials that retain heat (i.e. metal in direct sunlight)
- Avoid products with sharp edges or components potentially hazardous to pedestrians.
- Able to be securely attached to the sidewalk and able to be easily relocated if necessary.
- At stops with high boardings, provide opportunities for resting, including lean bars. A leaning bar rises 30-38" and allows customers to rest while waiting

The MBTA recommends an all steel bench with a black finish. Benches deviating from these guidelines may be acceptable but must be reviewed and approved by the MBTA.

Bench style, color and placement should always be coordinated with local and municipal roadway and streetscape improvement programs.

Installation Considerations

- Locate benches so they don't interfere with front landing pad and rear door loading areas. A 4 foot wide clear path of travel must be maintained throughout the bus stop zone and to the adjacent sidewalk.
- Provide 30 x 48 inch clear space alongside bench for a wheelchair to rest.
- Bench positioning and facing on the sidewalk should consider pedestrian flows, snow plowing and proximity and speed of adjacent roadway traffic. These factors may influence decision to place the bench at the front or the back of the sidewalk. In general, placement at the back of sidewalk is preferred.
- Benches should be placed facing the street where possible.

- If a bench is being installed adjacent to a shelter with an advertising panel, the bench shall be located to the right of the shelter so that the advertising panel doesn't block the line of sight between seated customers and an approaching bus.
- If possible, locate benches in building shadows. Do not locate benches where they might be susceptible to bird droppings.
- Benches should be surface mounted and anchored with tamper proof bolts to prevent unauthorized movement. Installation should allow for potential future relocation and/or removal in the event of bus route changes, street improvement projects, etc.
- Multiple benches should be provided depending on demand. Benches can also be added to supplement benches in shelters. Two benches should be considered at stops where daily boardings exceed 150. Benches placed side by side should not be closer than 4' from each other.

In addition to the amenity clearance requirements mentioned previously, the following clearances must be adhered to:

Element	Clearance/Path Of Travel	
	Minimum	Standard
Between bench and curb line/edge of street (bench faces street)	5'	6'
Between bench and curb line/edge of street (bench does not face street)	18"	3'
Clear sidewalk width in front of a bench [1]	5'	6'+
Clear sidewalk width behind bench	4'	6'+
Space adjacent to a bench for a wheeled mobility device	30"x48"	

[1] 4' minimum plus 1' to accommodate person's legs. 6 feet or more should be provided depending on pedestrian volumes.

Trash Receptacles

The MBTA and/or a Municipality may seek to install trash receptacles at bus stops. Receptacles should be located where they do not create barriers to accessible bus boarding or sidewalk usage. Several types of receptacles are in use including cylindrical open topped steel containers and solar powered trash compactors.

Trash receptacle specifications should address the following:

- Resistance of materials and paint treatments to weather conditions, graffiti, cutting, fire, and other forms of vandalism
- Appropriateness of the design to the neighborhood
- Anchor trash receptacles to prevent unauthorized movement or accidental tipping but also to facilitate possible relocation to accommodate bus route changes, street improvement projects, etc.
- Avoid installing trash receptacles with design features that permit liquids to pool or remain near the receptacle and attract insects
- If possible, install trash receptacles in shaded areas away from benches and shelters. When installed in areas that receive direct sunlight most of the day, the heat may cause foul odors to develop
- Where practical, place barrels at back of sidewalk to avoid potential conflicts with bus loading zones.



The standard MBTA receptacle is a painted steel drum with a removable plastic liner having a 35 gallon minimum capacity. Said receptacle should have a small opening to discourage placement of household trash.

Maintenance and emptying of trash receptacles is generally not the responsibility of the MBTA. For any trash receptacle installed, the municipality must agree to maintain and empty the trash.

The minimum sidewalk width required to accommodate a trash receptacle is 7.5 feet. This should be increased depending on the volumes of pedestrian traffic. A trash receptacle shall be placed no closer than 12 inches from the curb line.

Lighting

Adequate lighting is important for customer comfort, safety and security as well as to enable bus operators and traffic to see waiting customers. Bus stops that are served after dark should be located where they will be illuminated, preferably from an overhead street light. If crosswalks are being provided, they also should be illuminated. In certain cases where warranted, lighting should be installed at the stop. Care should be taken to ensure that overflow lighting doesn't adversely impact abutters. In addition to street lights, stops can be lit by advertising panel backlighting installed at certain bus shelters. If a shelter is present, both interior and area lighting are recommended. The placement and

maintenance of lighting is normally the responsibility of the local Municipality, except at advertising shelters where the interior lighting is provided and maintained as part of the shelter.

Newspaper and Vendor Boxes

Newspaper and vendor boxes can provide waiting transit customers with convenient access to reading material. However, care must be taken to not obstruct access to the landing area, loading zones, sidewalk, or shelter. Newspaper boxes should not be chained or otherwise affixed to the bus stop sign pole, shelter, or bench. Most Municipalities have laws or ordinances restricting the placement of vendor boxes.

Landscape Features

Landscaping can enhance the level of customer comfort and attractiveness of transit, but should be positioned and maintained so that safety and accessibility are not compromised by planters, encroaching bushes, uneven grass surfaces, etc.

- The bus stop zone should be free of plantings to avoid potential conflict with bus boarding and alighting areas. If existing plantings will be difficult to remove, then the bus stop location may need to be adjusted.
- Ensure that landscaping does not obstruct bus stop sign visibility. Tree branches that extend into the roadway below 12 feet should be trimmed back at least 2 feet from the curb.
- To maintain an accessible and safe path of travel, all tree branches must not extend lower than 80 inches above a path of travel.
- Tree grates within bus stop zones are discouraged since they can create uneven surfaces over time. The tree roots grow and potentially create grate heave, obstructing the path of travel. Many older tree grates are not ADA compliant and should be replaced where located within the path of travel.

Technology Features

Where feasible and warranted, bus stops should include provision for a wide variety of “technology” features. Bus stop design should make provisions for the following:

- Real-time electronic countdown signs and/or screens displaying “next-bus” arrival information and other general service information.
- Police and/or customer information call boxes
- Button-activated on-demand bus stop request indicator lights at low ridership stops where bus operators may have trouble seeing waiting customers.
- Camera systems for bus stop parking enforcement and/or security.

To prepare for such technologies, consider providing electrical and communications conduits. Using wireless data has a lower capital cost and should be used if a physical connection is not feasible. Where feasible, solar is also a preferred power source.

Developer Responsibilities

When a development is constructed adjacent to or in close proximity to an existing or proposed bus stop location, the developer should be responsible for providing amenities as described in this section. Municipalities are encouraged to require the placement of shelters that conform to local standards for customer recognition and ease of maintenance. All street improvement and redevelopment plans should be submitted to the MBTA to ensure proper coordination and placement of transit amenities.

Bicycle Parking

Bicycle parking facilities, such as bike racks, lockers or Pedal & Park bike cages should be considered at bus stops and terminals. Designated bicycle parking facilities discourage the practice of locking bicycles in areas that interfere with pedestrian and bus customer path of travel. Confining bicycles to one area can reduce visual clutter and maintain appropriate pedestrian clearances.

- Locate parking facilities away from other pedestrian or bus customer activities to improve safety and reduce congestion.
- Ensure that parked bikes are visible at all times. Do not locate bicycle parking where views are restricted by a bus shelter, landscaping, or existing site elements.
- Design and placement of parking facilities should complement other bus stop furniture.
- Covered or weather-protected parking locations are an important bonus to bicyclists.

For most bus stops, provide one or more “post & ring” or “inverted U” style racks. These should be placed away from bus stop curb clearance zones and outside of the paths of travel. The rack should be located so that no matter how a bike might be locked to it, the bike or rack will not obstruct the path of travel. The racks should only be installed at bus stops where the sidewalk width exceeds 8 feet.

Bike Rack Installation Detail

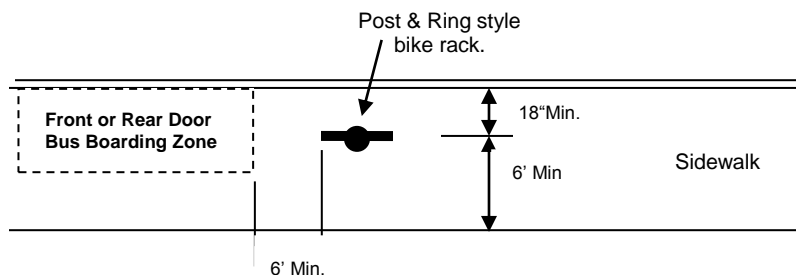

7. SHELTERS

A sheltered waiting area provides bus customers with comfort and protection from the elements while awaiting a bus and also helps to identify and market a bus stop.

These guidelines are intended to provide planning, design and procurement guidance for the following situations:

- An entity requests that the MBTA install a shelter at a particular bus stop
- The MBTA or other entity initiates a program to upgrade a bus corridor or bus stop with a new shelter or the replacement of an existing shelter
- A municipality or other entity seeks to install their own shelter at a bus stop

Current Bus Shelter Programs

The MBTA services over 7,600 bus stops. Approximately 600 of these currently have shelters. The shelter type, ownership, and maintenance responsibilities vary considerably. Shelters can generally be classified into three categories:

- Advertising shelters
- MBTA-owned shelters
- Private and/or municipally-owned shelters

A common method of funding shelter procurement and maintenance is to contract with an outdoor advertising firm. Said company furnishes, installs and maintains shelters in return for the rights to install advertising in the shelter. This revenue is shared with the Municipality and/or the MBTA. These are usually high quality shelters with stainless steel and glass components. They generally have back-lit advertising panels and seating. Some municipalities are opposed to this type of outdoor advertising, and thus do not participate in the program.

Starting around 2001, both the MBTA and the City of Boston entered into separate advertising shelter contracts-The MBTA with CEMUSA and The City with JC Decaux. In 2015, JC Decaux acquired CEMUSA so all advertising shelters are presently owned and maintained by JC Decaux.



CEMUSA Model "2001" Shelter



CEMUSA Model "Pal-Li" Shelter

The MBTA has a 15 year contract with CEMUSA (now JC Decaux) to install and maintain bus shelters within select communities in the MBTA network. Approximately 200 "CEMUSA" shelters have been installed in 9 communities. After contract expiration in 2019, ownership of these shelters reverts back to the MBTA and the contract will most likely be rebid.

The City of Boston has a contract with JC Decaux (formerly WALL USA) to install and maintain street furniture – including bus shelters with advertising. Approximately 300 JC Decaux shelters are located at City of Boston bus stops. JC Decaux also has several shelter types in use. After contract termination in 2026, ownership of these shelters reverts to the City of Boston



JC Decaux Shelter

The MBTA owns and maintains approximately 400 non advertising shelters. They range from aluminum and polycarbonate modular units to larger glass and stainless steel shelters on the Silver Line.



MBTA Standard Shelter – Full size



MBTA Shelter (narrow version)

Many privately owned and municipally owned shelters have been installed throughout the MBTA system. Some are on public rights-of-way, while others are on private property. The MBTA generally has no maintenance responsibility for these shelters.

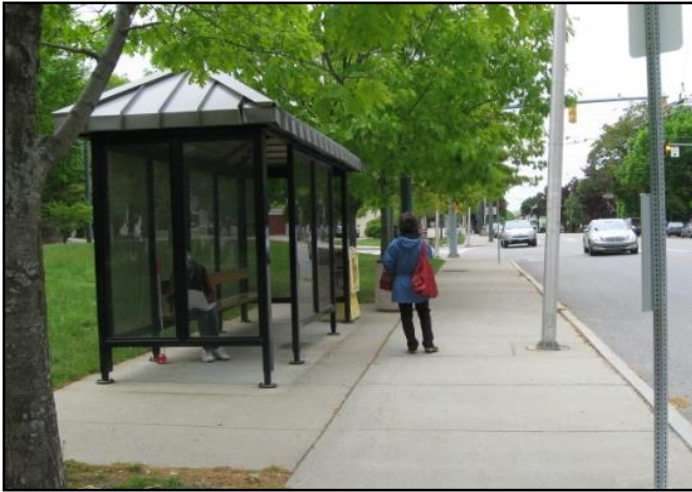

Municipal Shelters

The shelter needs of a bus stop vary with each bus stop location and must be determined on a site by site basis. The criteria listed below help to prioritize which stops are eligible for shelters. This ensures that the shelters will be used to the fullest potential at each location. Discussion regarding the exact positioning and configuration of a bus shelter at a particular stop is presented later in this Chapter.

MBTA Shelter Policy

Given fiscal constraints and land availability, the MBTA is not able to provide bus shelters at most of its 7,700 stops. To fairly distribute shelters systemwide, this Shelter Policy provides guidance for the placement of bus shelters and establishes a procedure for evaluating shelter requests. This policy in no way establishes a requirement for placement, since all placements will be dependent on available resources.

In areas or locations where the MBTA, or its contractors, are the primary suppliers of shelters at bus stops, placements must:

1. Conform with shelter eligibility standards
2. Pass a site suitability test,
3. Meet the requirements of Title VI, and
4. Be fully compliant with accessibility regulations

1. Shelter Eligibility Standards

Customer utilization is the primary consideration for shelter eligibility. All bus stops that meet the required number of boardings will be eligible. Table 7.1 lists all criteria to be factored into an assessment of eligibility for each bus stop and the value associated with each criterion. A site must receive a total of 70 points to be considered eligible under this policy. The following criteria are considered:

- **Customer Utilization** - The number of customers boarding at a stop on an average weekday. Any bus stop that has more than 70 boardings is automatically eligible for a shelter. For bus stops with fewer boardings, a combination of the factors listed below are considered in determining eligibility. Stops that have fewer than 25 boardings are not eligible for a shelter.
- **MBTA Initiatives to strengthen route or stop identity** - If the stop is located on a designated Key Bus Route or if it will serve a potentially highly transit dependent development.
- **Demographics** -The bus stop is in close proximity to medical facilities, senior housing and/or is utilized by significant numbers of elderly persons and/or persons with disabilities.
- **Minority and/or Low income areas** - If the stop is in a Title VI or “Environmental Justice” community.
- **Connectivity** - The bus stop serves as a major transfer point to another transit or bus route.
- **Frequency of Service** - Bus stops that are serviced less frequently are more likely to qualify for a shelter, due to the longer time that customers may be waiting for a bus.
- **Site Conditions** - Bus stops that have extreme exposure to adverse weather elements.

For shelters that are procured, installed and maintained by others, it’s not necessary for the shelter to meet these eligibility standards, however it is strongly recommended for transit equity purposes.

Table 7.1: Bus Shelter Eligibility

Eligibility Criteria	Points
70+ Average weekday boardings	70
25-69 Average weekday boardings	50
MBTA initiative to strengthen route or stop identity	10
Facilities for seniors, disabled, medical or social services nearby	20
Minority and/or low income area	15
Bus route transfer/connection point	5
Infrequent bus service (no more than every 30/60 minutes peak/off peak)	10
Poor site conditions at bus stop (weather exposure etc.)	10

Passing Score: 70

2. Site Suitability Test

The following physical and practical requirements must be met before a shelter can be considered:

- **Site ownership:** Permission to install a shelter must be granted by the land owner. In most cases this is the municipality since they generally own the sidewalk. In some cases, property easements, license agreements and/or takings may be required if the sidewalk width isn't adequate and the shelter will encroach on adjacent property.
- **Abutter approval:** Depending on the jurisdiction, it may be necessary to notify and/or obtain abutter approval depending on the proposed shelter setback from the property line.
- **Adequate physical space and clearances:** This typically pertains to sidewalk widths and the proximity of various potential obstacles to an accessible and safe path of travel (POT). There must be sufficient space for the shelter, as well as an accessible POT around the shelter and between other street furniture. The busier the sidewalk, the more space is required. In addition, shelters must be sufficiently set back from the curb to avoid being struck by vehicles. Where sufficient sidewalk width is not available, options may include installation of a narrow shelter, sidewalk widening, or a curb extension/bulb out.
- **Proximity to the bus stop:** The shelter should generally be located within the limits of the bus stop zone-or no greater than 50' from the designated bus boarding area.
- **Community and municipal approval:** For advertising shelters, a license agreement between the municipality and the shelter company is generally required. A permit may also be required from the State Office of Outdoor Advertising (OOA).

3. Title VI Requirements

Title VI of the 1964 Civil Rights Act is defined in FTA Circular C 4702.1. Title VI and Environmental Justice principles mandate that MBTA services-including shelters and amenities- are distributed in such a manner that minority and low-income communities receive benefits in the same proportion as the total service area. The MBTA and CTPS periodically conduct a Title VI analysis to ensure compliance. At times there may be a disparity that needs to be addressed.

4. Accessibility Requirements

Installation of a bus shelter may trigger specific accessibility requirements. This includes bus stop lengthening (see Chapter 4), an accessible bus landing pad and an accessible path of travel between the landing pad, the sidewalk and the shelter (see Chapter 5).

Shelter Specification Guidelines

For standardization purposes, MBTA shelters fall into three basic categories:

- A standard shelter is 5 feet deep and 12-18 feet long. Back and side windscreens should be provided and depending on length and configuration, a front windscreen may be recommended as well.
- For more constrained locations, a narrow style shelter is appropriate. These are 1-3 feet deep depending on if side windscreens are provided. They are also 12-18 feet long. To protect all customers, the canopy needs to be at least 4 feet wide.
- Customized shelter designs generally create maintenance issues but may be appropriate at certain locations and shall be permitted as directed by the MBTA.

The MBTA tries to utilize a standardized shelter design to help ease maintenance functions and to keep the bus stops easily identifiable to customers. The following factors shall be considered when buying a shelter or developing a specification:

- Strength and durability of structure and materials
- Resistance of materials and paint treatments to weather conditions, graffiti, cutting, fire, and other forms of vandalism
- Need for internal lighting-depending on location and availability of external lighting. A lighting level of from 2- to 5 foot-candles is preferred throughout the shelter for customer comfort and safety.
- Appropriateness of the shelter design to the community
- Ease of maintenance
- Semi-transparent enclosure that allows full visibility for bus operators and waiting customers
- Shelter roof shall drain away from waiting customers, passersby and boarding area.
- Shelter procurements shall include spare components to facilitate maintenance.
- Shelter shall be surface mounted to facilitate removal/relocation if needed.

- Minimum vertical clearance inside the shelter of 7.5 feet shall be maintained.
- Shelter shall have owner's name and 24-hour telephone number displayed for emergency purposes and maintenance.
- Seating for at least three or four people shall be located within the shelter (see Bench Guidelines in Chapter 6).
- Provide a minimum 32 inch by 48 inch clear floor space within the shelter and under the roof for persons with disabilities.
- Shelter wind screens shall maintain a 3-6 inch vertical clearance above sidewalk to avoid buildup of trash and debris and to facilitate drainage and interior cleaning.
- For cost efficiency, maintenance purposes, aesthetics and service identity, standardization is strongly encouraged.

For larger shelters, full or partial front windscreens shall be provided. This is critical if waiting customers may be exposed to roadway spray. Front windscreens are sometimes not recommended since they can obstruct views into the shelter, and they may also interfere with accessibility within the shelter.

Placement

- Locate in close proximity to the bus boarding area to facilitate timely customer loading.
- If necessary, the designated landing pad area can extend into the clear floor space of the shelter.
- Provide an accessible path of travel between the shelter and the bus stop landing pad. If feasible, shelter should also be connected to the adjacent sidewalk network via an accessible path of travel.
- The shelter floor shall have a 1.5% maximum cross slope to facilitate drainage. The shelter shall be installed level-even on sloped sidewalks.
- Do not place in front of regularly used building access points.
- Do not place in front of storefronts or building windows used for commercial purposes (e.g. advertising, display, business names, etc.).
- Locate to avoid exposing occupants to splashing water from passing vehicles and runoff from adjacent buildings and landscaping.
- Position so that orientation maximizes protection from wind and rain, and with consideration of the sun's angles to allow maximum shade during peak use in the morning and afternoon.
- Avoid locations that block sight distance at intersections or driveways. This can normally be accomplished by placing the shelter more than 25 feet from the beginning or end of curb return of an intersection or driveway.
- For bus stops with high boarding counts, multiple shelters are recommended.
- Face the open side of the shelter towards the roadway to provide maximum visibility for bus operators and shelter occupants. For shelters with ad panels this is particularly important as the ad panel cannot block visibility for customers. Consideration may be given to siting shelters open to the sidewalk, with the back facing the roadway, in certain circumstances and where ad panels are not applicable
- Install bollards or other protective devices at situations where shelters may be susceptible to damage from cars. (I.e. adjacent to parking lots etc.)

Figure 7.1 shows minimum and preferred shelter clearance dimensions. The sidewalk or bus stop cross section is the critical element in determining site suitability.

Figure 7.1: Shelter Sidewalk Clearances

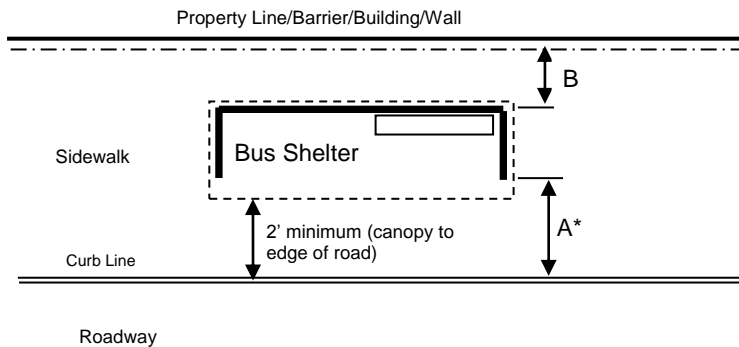

A*: If no side windscreen, then dimension is to edge of bench

A		Notes
Minimum	Standard	
2'-3'	6'	3' is absolute minimum as long as there's an accessible path of travel into the shelter AND a 4' minimum POT behind the shelter (Dimension B). 2' is allowable if there's an alternate POT into shelter (a windscreen is removed). If there are no side windscreens and just a bench, or if there's a front windscreen, then at least 4' must be provided.

B		Notes
Minimum	Standard	
6"	1'	If maintenance workers are able to access back of shelter
1'-2'	2'	Minimum to facilitate shelter maintenance when there is a building or barrier present. (12" for CEMUSA shelters, 24" for JC Decaux Shelters)
4'	6'	If this is the primary sidewalk path of travel
	6'+	For sidewalks with high pedestrian volumes

The following clearances shall be adhered to:

Element	Clearance/Clear Path of Travel	
	Minimum	Preferred
Fire hydrant or driveway	10'	12'
Street furniture	3'	5'
Building entrances	5'	10'
In-ground elements (manholes, tree grates, handholes etc.)	1'	3'
Between front of shelter and curb line or edge of road. [1]	3'	5'
between any shelter element and curb line/edge of road to avoid collision with bus side mirrors	2'	
path of travel to enter and exit shelter [1]	4'	
Crosswalk (for visibility)	15'	

[1] If a 4' minimum clear path cannot be provided in front of the shelter, an alternative is to remove a shelter side windscreen and provide a 4' wide clear path behind the shelter, and 2'- 3' wide path in front of the shelter. With this configuration the bus shelter must be sited outside of the clear zone and so the removed side panel faces the landing pad, in order to allow for easy and quick access between the shelter and the bus. This assures that visual contact is maintained between customers and bus operators, which would be obscured if a customer has to maneuver around the back of the shelter.

Shelter Foundations

Foundation designs vary depending on the particular shelter type and manufacturer. The typical foundation consists of a structural concrete slab. The shelter is surface mounted with anchor bolts. Some shelter models, including those provided by JC Decaux/CEMUSA, have recessed base plates, and/or individual concrete footings for the shelter supports. Shelter slabs shall be flush with the adjacent sidewalk surfaces to facilitate an accessible path of travel. Cross slopes shall be provided for drainage but shall not exceed 1.5%.

Power Requirements

Where feasible and appropriate, provisions should be made for electrical service at shelters. This can be either an underground conduit connection to a municipal electrical utility company service, or solar panels located on the shelter roof. Electricity at shelters can be used for shelter interior lighting, illumination of advertising panels, real time information signage, overhead radiant heaters and police call back systems. Solar systems shall incorporate batteries and an adequate warranty. All electrical systems shall include manual and automatic shutoff systems to enable shutdowns after service hours.

Customer Information

The stop name and ID # shall be displayed at every shelter. The information shall be displayed in a visible location at least 7 feet from ground level, either above the right side panel, or facing the curb. The official stop name and identification number will be provided by the MBTA Service Planning Department upon request.

The name and telephone number of the shelter's owner shall be displayed inside the shelter to facilitate customer inquiries, maintenance requests and emergencies.

At some locations, a secure enclosure to facilitate the posting of system maps and other service information shall also be provided (such as how to access real-time bus arrival information by phone). The case shall be vandal-resistant and suitably sized for maps. To maintain a consistent format, all maps and service information shall be provided by the MBTA Service Planning Department.

Shelter Maintenance

Shelter maintenance includes cleaning, vandalism repairs, snow and ice removal and general wear and tear. Graffiti and scratched or broken glazing are common maintenance challenges. Maintenance is generally the responsibility of the party or jurisdiction that owns the shelter and/or the sidewalk, or the contracted vendor for advertising shelters. Shelters should not be installed without a maintenance agreement in place.

8. SIGNAGE & CUSTOMER INFORMATION

Signs serve as a source of information to customers and bus operators regarding the location of the bus stop and are excellent marketing tools to promote transit use. The bus stop can be the customer’s initial point of access to the system and as such should inform customers that they are at the correct location to catch a specific route in a specific direction. Other bus stop customer information may include system and neighborhood maps, schedules and general service information. The bus stop sign:

- Identifies the location as a designated bus stop and informs transit customers, bus operators and other road users/operators
- Publicizes the availability of bus service
- Identifies the transit operator serving the stop
- Provides route-specific service information for customers
- Displays contact information
- Defines the physical limits of the bus stop and relevant parking regulations

All bus stop signage must comply with MBTA graphics standards. All artwork for bus stop signs will be provided by the MBTA.



Sign Placement and Installation

The primary or front bus stop sign shall be placed in close proximity to where customers board at the front door of the bus. The sign also serves as a guide for the bus operator in positioning the vehicle at the stop. Each bus stop shall be provided with a front or “header” sign. Rear signs should be provided where there is a possibility of stopped vehicles obstructing the bus stop.

Signs should be securely mounted on their own post or other approved standard. Where possible, bus stop signs should be placed independently of all other street signs to maintain transit stop identity. In some instances, to minimize excessive sign clutter and sidewalk path of travel obstructions, other signs, such as adjacent parking regulations etc., may be mounted below an MBTA bus stop sign on the same post. However, all sign mounting heights must be ADA compliant.

Signs must be easily visible to the approaching bus operator. Bus stop signs should neither block nor be blocked by other jurisdictional signs.

The exact positioning of the front and rear signs is dependent on several factors including bus stop location, location of the accessible landing pad, adjacent parking and proximity to crosswalks. (Refer to Chapter 4 for details). The sign locations establish the limits of the zone needed for the bus to pull into and exit a bus stop. The signs demarcate the no parking zone and serve as a guide for the bus operator in positioning the vehicle at the stop.

All sign posts shall be installed 18" (12" minimum) from the face of curb or edge of roadway. This will prevent collisions with most vehicles and bus mirrors. Bus stop sign posts must not interfere with a safe and accessible pedestrian path of travel. A minimum 4' clear path of travel must be maintained around posts. At locations with narrow sidewalks or other constraints to the path of travel, it may be necessary to install the sign post at the back of the sidewalk.

For sign locations where posts are vulnerable to getting hit by vehicles (adjacent to driveways, streets etc.) sign posts should be set at least 3' back. It is sometimes advantageous to mount bus stop signs on existing structures that are less susceptible to being hit and/or damaged.

Front or header sign face shall be set at a 90° angle (perpendicular) to the curb, facing oncoming traffic. Rear signs shall be set at a 60° angle to the curb.

The bus stop sign should be set at least 80" above grade but less than 10', consistent with Figure 8.1.

Where practical, new bus stop signs should be installed on a "P-5" 2" x 2" square tube steel post perforated by mounting holes at 1" spacing. This post type also facilitates double sided signs facing both directions. Where feasible, posts shall utilize a sleeve type "breakaway" base that facilitates easy post replacement. It may be feasible to utilize a properly located existing post, light pole etc. in lieu of a new post-especially if a new post would create sidewalk clutter and an obstruction to the path of travel.

For stops that serve multiple routes, and the route descriptions do not fit onto a single sign, two signs shall be installed back to back on the same pole.

Content and Fabrication

All MBTA bus stop signs (front and rear) shall be 12" wide and either 32" or 40" tall depending on content. They should be fabricated from aluminum with a reflective background for nighttime visibility. Unless otherwise directed, all bus stop signs are fabricated and printed by the MBTA sign shop. Exact sign content and dimensions are provided by and/or approved by the MBTA Service Planning Department.

Figure 8.1: Sign Installation Detail

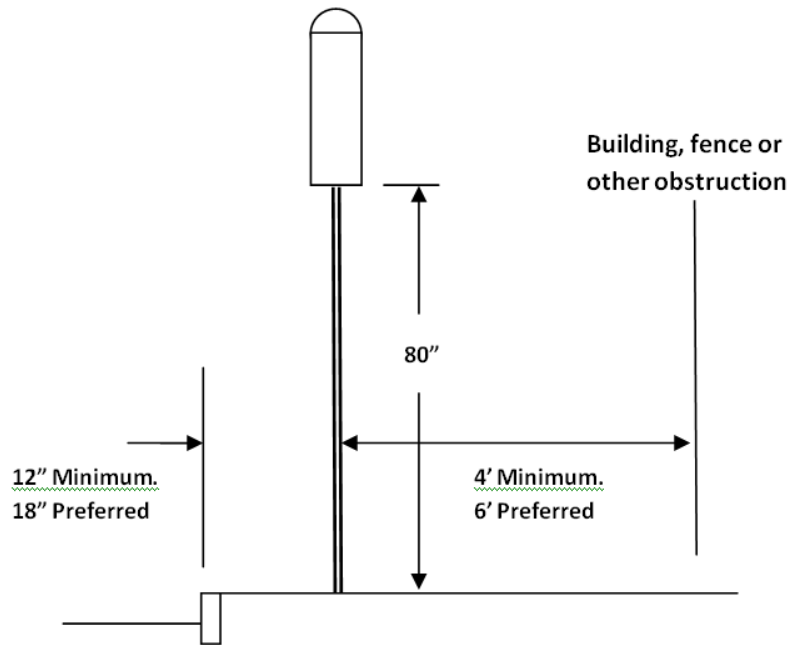

Schedule Cases

Many existing bus stops provide schedule display cases mounted to the bus stop sign post. There are several types currently in use—including 4-sided “cubes”, single faced “monopanel”, and “schedule tubes”. Due to the inability to update these cases on a regular basis, they are being phased out and should be removed anytime a bus stop sign is relocated or a new pole is installed.

At major bus terminals and in many bus shelters, schedules are displayed in enclosed display cases. Folded paper schedules are also available at some locations for customers to take away. All bus terminals should be provided with racks for folded paper schedules.

Maps

A variety of map types are used by the MBTA to provide transit information to bus customers. They can be placed in stations, shelters and on vehicles. They generally show bus route information and transit transfer points. Often the map also includes service information. Bus route maps should be located at all major bus terminals and stops.

Bus Terminal Signage

Bus terminals typically have designated and/or shared berths which require unique signage designs. In addition to the actual berth signage, locus maps may be necessary to enable customers to find the actual berths. The design of these graphics should be coordinated with the MBTA Capital Delivery

Department. Bus terminals should also include route maps, cases for the display of route schedules, and general customer information.

Electronic Signage

GPS now enables the MBTA to provide real-time bus arrival data to customers. While this information is readily available to anyone with a Smartphone or a computer, there may also be situations where it can be provided to customers via electronic signage. Monitors/displays can be provided in strategic locations within major bus terminals to provide customers with bus arrival times for multiple routes. Monitors should be vandal resistant and fully accessible to provide information both visually and audibly. Additional guidance on electronic signage can be provided by the MBTA.



Departure Countdown Sign

Bus Stop Sign Maintenance

To maintain quality control, bus stop signs are typically fabricated, installed and maintained by the MBTA. However, some municipalities handle the installation on their own. For roadway improvement projects, the MBTA shall review and approve the bus stop signage locations and signage graphics. In these cases, the installation of signs and posts may be the responsibility of the contactor or project proponent.

9. BUS TURNOUTS AND CURB EXTENSIONS

Bus stops shall be designed to accommodate the amenity needs of customers, while providing a safe, accessible and functional bus operating environment, all while minimizing parking impacts and traffic congestion. Curb extensions (also referred to as bus nubs/bulbs) or bus turnouts (bus bays) may be desirable at select stops to achieve these objectives.

Bus Turnouts

In areas where the impact of the bus blocking a travel lane creates unacceptable traffic delay or potential hazard, provision should be made for a turnout, paved shoulder or other area of adequate curbside clearance so the bus does not have to stop in the travel lane.

Advantages:

- Allows traffic to proceed around the bus, reducing delay for general traffic
- Maximizes vehicular capacity of roads
- Clearly defines the bus stop
- Customer loading and unloading can be conducted in a more relaxed manner
- Reduces likelihood of rear-end accidents



Disadvantages:

- More difficult to re-enter traffic, potentially increasing bus delay.
- Uses additional space and may require right-of-way acquisition
- May reduce sidewalk widths and impact pedestrian traffic

Bus turnouts are recommended where street traffic averages 40 mph or more and at least one of the following conditions exist:

- Average peak period dwell time exceeds 30 seconds per bus.
- There's a high frequency of accidents involving buses and/or pedestrians.
- Peak period traffic in the curb lane does not exceed 1,000 vehicles/hour and the curb lane is less than 20' wide.
- Bus volumes exceed 10 or more per peak hour.
- Where stops in the curb lane are prohibited.
- Where sight distances prevent traffic from stopping safely behind a stopped bus.
- At stops where there are frequent wheelchair boardings.
- Where buses are expected to layover at the end of a trip.
- Where there is adequate space for turnout length and depth to allow a bus to safely exit and reenter the flow of traffic.

An open turnout is a variant where the turnout is open to the upstream intersection. The bus operator has the pavement width of the upstream cross street available to decelerate and to move the bus from the travel lane into the bay, allowing the bus to move efficiently into the bay as well as to allowing the bus to stop out of the flow of traffic. Re-entry difficulties are not eliminated; however, they are no more difficult than with a typical bus bay design. A disadvantage for pedestrians is that the pedestrian crossing distance at an intersection increase with an open bus bay design because the intersection width has been increased by the width of the bay. This additional required crossing time also increases the vehicle delay at signalized intersections.

Design Guidelines

- Twelve foot width is desirable to reduce sideswipe accidents, ten foot width is minimum. On streets with bike lanes and where bus layovers occur, the turnout should be wide enough so that buses do not impede the bike lane.
- The overall length varies depending on the entrance speed and the number of buses to be accommodated.
- The far-side of an intersection is the preferred location for turnouts. At signalized intersections, the signal can create gaps in traffic allowing the bus to re-enter the traffic flow.
- Near-side turnouts typically should be avoided because of conflicts with right turning vehicles, delays to transit service as buses attempt to re-enter the travel lane, and potential obstruction of pedestrian activity as well as traffic control devices. The exception would be where buses would use a right turn lane as a queue jump lane at an intersection (where a far-side turnout is not possible).
- Turnouts in mid-block locations should be avoided unless associated with key pedestrian access to a major transit-oriented activity center and subject to the general guidelines above.

Curb Extensions or Bulb Outs

Curb extensions, also known as bus nubs or bulb outs, align the bus stop with the parking lane, creating an in-lane stop. This enables buses to stop without making large lateral shifts. This also solves the problem of locating bus customer amenities in dense urban environments with considerable pedestrian traffic. They also reduce the need to displace parking spaces to achieve improved bus stop accessibility. A curb extension is essentially a sidewalk widening extending into the parking lane which is directly adjacent to the travel lane. When used as a bus stop, a bus will stop in the traffic lane instead of weaving into the parking lane—as they do at curbside bus stops. Moreover, when space limitations prevent the inclusion of amenities, curb extensions create additional space for shelters, benches, and other streetscape amenity improvements along sidewalks. Curb extensions also provide enough space for bus customers to comfortably board and alight the bus away from nearby pedestrian traffic. Finally curb extensions reduce pedestrian exposure to on-street vehicles and work well in conjunction with adjacent crosswalks by effectively reducing the crossing distance.



Curb extensions should be considered at sites with the following characteristics:

- High pedestrian activity
- Crowded and/or narrow sidewalks
- A need to reduce pedestrian crossing distances
- Vehicles routinely block the bus stop
- Bus already stops in travel lane
- The need to minimize loss of street parking
- There are multiple travel lanes, enabling vehicles to bypass a stopped bus

Curb extensions have particular application along streets with lower traffic speeds and/or low traffic volumes where it's acceptable to stop buses in the travel lane. Collector streets in neighborhoods and designated pedestrian districts are good candidates for this type of bus stop.

Located at crosswalks, they effectively reduce crossing distances thus protecting pedestrians. The potential for a curb extension at a bus stop is generally determined by roadway width, travel lane configuration, and traffic and pedestrian volumes. Although it requires that the bus stop in the travel lane, the bus stop will require significantly less curb space which minimizes parking impacts and deters illegal parking. The stopped bus remains in the travel lane so delay re-entering the general traffic flow is minimized. The bus can pull parallel to the curb, and there is a larger waiting area for customers, which can offer an opportunity to add customer amenities such as a bus shelter.

The curb extension width is limited by width of the adjacent parking lane, and the length should be long enough to allow customers to board/alight at all bus doors. Coordination in placement of street amenities, hydrants, utility poles, street lights, and signs needed to ensure clearance at doors.

Curb extensions also help to facilitate the separation of general pedestrian flow from pedestrian activity associated with the bus stop, which is important in congested or high volume pedestrian areas.

Curb extensions should not be used where the frequency of buses or dwell times could cause significant delay to following buses or where there is no opportunity for general traffic or following buses to bypass the stopped bus. One compromise approach is to provide curb extensions at alternating stops so that the bus is able to pull out of the travel lane at every other stop and thus allow traffic to pass.

At streets where speeding is a known concern for pedestrians, bulb-outs may be worthwhile to assist in traffic calming and improving pedestrian crossing safety. Note that bulb-outs need not be a full lane width.

Bulb outs often require drainage modifications; if catch basins cannot be moved, use trench drains covered with walkable grates along the length of the boarding bulb.

Many transit agencies utilize temporary or removable bus bulb outs. These are less costly to install and can be easily removed if they result in undesirable traffic operations.

10. OTHER BUS STOP ELEMENTS

Roadway and Intersection Design

Roadways and intersections with bus traffic and bus stops should be designed to accommodate the size, weight and turning requirements of buses.

Because of their need to make frequent stops, buses generally travel in the traffic lane closest to the curb. Therefore, the following bus clearance requirements in roadway design are important.

- Overhead obstructions shall be a minimum of 12' above the street surface
- Obstructions shall not be located within 2' of the edge of the street or curb to avoid being struck by a bus mirror
- A traffic lane used by buses should be at least 12' in width because the maximum bus width (including mirrors) is about 10.5'. In certain situations, 11' may be acceptable.

Typically, the maximum roadway grade for buses is 6-8%. Steeper grades will interfere with bus performance where snow and ice are factors.

Curb reveals at bus stops should be between 6" and 9". Anything above this will interfere with bus's ability to align parallel and adjacent to the sidewalk since it will often have to overhang the curb while pulling in.

The turning radius of buses affects the design of intersections and dedicated bus facilities. While the curb radius and other roadway design features of municipal streets is governed by the appropriate municipality, the typical turning radius of MBTA buses should be considered as it will affect the ability of buses to operate safely on roadways with minimal encroachment into other lanes of traffic. The corner curb radii used at intersections can affect bus operations when the bus makes a right turn. Factors to consider include potential bus encroachment into adjacent lanes when turning, impact on pedestrian crossing lengths, and on-street parking

Bus Stop and Roadway Pavement

Most MBTA bus stops are located on roadways owned and maintained by the state and/or municipalities, and do not require special materials to be used. However, due to increased bus weight, as well as the increased loads associated with bus starting, stopping, and turning, alternative pavement treatments should be considered where appropriate. Pavement at bus stops shall be durable, visible and easy to maintain.

Bus starting and stopping maneuvers can introduce a force of over 28,000 pounds per axle on a repetitive basis at bus stops and bus lanes. This force is best absorbed by the roadway when the bus stop area pavement is reinforced with either concrete or bituminous pavement.

If a bus stop is located on a roadway that is planned for any sort of reconstruction or pavement maintenance, then the pavement design at the bus stop should be evaluated. In many cases, the standard roadway pavement design is adequate; however, on high volume bus routes, terminals or routes that operate heavier 60' articulated buses, a more robust bituminous concrete or cement concrete pavement should be utilized. For instance, concrete bus stop pads are provided along the Silver Line Washington street corridor for that very reason.

Concrete pads have excellent durability and are more visible to pedestrians and motorists, however they are more costly to construct. Minimum design criteria for pavement and drainage considerations in bus stop design must comply with state and local roadway design standards. A concrete pad should be 11-12' wide and sufficiently long enough to accommodate 40' and/or 60' buses. Specifications for reinforced concrete and bituminous bus stop pavement designs can be provided by the MBTA Capital Delivery Department.

Traffic Signals

Bus stops are frequently located at signalized intersections. Traffic signal design should accommodate both buses and bus customers. The following should be considered in designing new traffic signal systems and/or upgrading/redesigning signals at existing intersections:

- Bus stops should not be located where stopped buses could obstruct visibility of traffic and/or pedestrian signals. (Far-side stops generally address this problem).
- Pedestrian signals with push buttons are especially important at bus stops since bus customers are likely to cross the street.
- At near side stops, traffic signal detectors should be located so as to be triggered by a bus serving the stop. Otherwise, the signal controller may not be actuated until other traffic passes.
- Where feasible, signal systems should incorporate Traffic Signal Priority functions to expedite bus service through the intersection.

Pavement Markings and Bus Stop Delineation

Pavement markings play an important role in bus stop delineation. Appropriate pavement markings decrease driver confusion, allow for safer and more efficient use of the roadway and help facilitate stop accessibility. Properly delineated bus stops are more visible for bus customers and bus operators. Stop delineation designates the area that a bus will need to enter and leave a bus stop, and helps to ensure that it doesn't get blocked by other vehicles.

Where necessary, the area of a roadway to be used as a bus stop should have clear pavement markings to alert bus operators, customers and other operators of its location. The overall marked area should be sufficient to accommodate all bus-related activities (entering, stopping and exiting). Details are provided below. Pavement markings should generally be applied only at stops that are likely to remain for some period of time since pavement marking removal may be difficult. Bus stops at locations with complicated curbside uses such as in business districts, often have complex signage, a mix of commercial and customer vehicles, and short-term parking zones. Here, it becomes increasingly important to delineate the bus stop to minimize confusion and keep the bus stop clear for buses.

White diagonal hatch line markings may be striped to delineate the entry and exit tapers and discourage blockage

It's not always necessary to delineate all bus stops with pavement markings. At locations where there isn't a demand for street parking—either short-term or long-term, then the bus stop is unlikely to be obstructed. Delineation is also not needed if the bus stops partially in a travel lane or where the bus stop is in a shoulder less than 6 feet wide.

Pavement markings are subject to approval by the authority governing the roadway and must comply with MUTCD standards.

Pavement markings require periodic maintenance if they are to remain effective. Ideally, this is performed at the same time as other roadway pavement markings are updated. The responsibility for maintenance should be addressed prior to making the decision to install markings.



Figure 3.2 Standard MBTA Bus Stop Pavement Markings

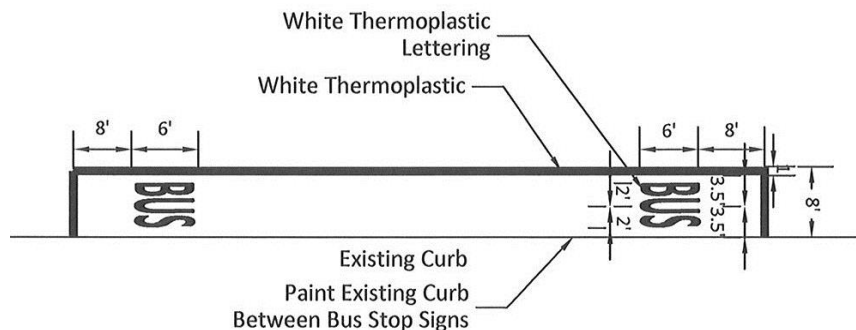

Miscellaneous Pavement Markings

Where adequate roadway width is available, there may be opportunities to designate a full or part time dedicated bus lane. The standard practice in these situations is to apply paint to the entire lane. This is demonstrated along portions of the MBTA's Silver Line. Using colored asphalt mix is also an option.

At certain bus stops it may be desirable to paint the curb alongside the bus stop to reinforce parking regulations. This may include the top and/or the face of the curb. Yellow and red are the colors most commonly used, but color will be determined by the MBTA and/or the municipality.

In some instances, it may be desirable to apply pavement markings and/or textures to the accessible landing pad and sidewalk to increase the visibility. This is especially helpful in situations where the bus operator and/customer may have trouble identifying the exact location of the landing pad.

On-Street Bicycle Lanes

Where bicycle lanes are shared with or overlap with the bus stop zone, specific markings shall be provided. Where possible, move the bike lane to the outside of the stop so that it becomes a protected lane. Sharrows or dashed lines on the bicycle lanes are typically used to alert bicyclists of the shared roadway space. The MBTA should be contacted whenever a bike lane is proposed to pass by a bus stop. These installations can have an impact on bus operations, especially if the bicycle treatment on the roadway will narrow or reduce the number of traffic lanes.



Line widths, colors, and general layout will often vary depending on existing site conditions and requirements of the roadway owner. Factors that may affect markings include bike lanes, crosswalks, stop lines, proximity to turn lanes, etc.

Fare Collection Considerations

The MBTA is planning to roll out a new fare collection system called AFC 2.0. This new system will include validators and vending machines at select high ridership bus stops. Once these are in place, customers will be able to board the bus at all doors. This will have a positive impact on customer convenience and service reliability.

To be effective, equipment should be positioned in close proximity to the bus boarding areas and appropriate directional and instructional signage shall to be provided.

Depending on final system development, it may be necessary to provide power and/or communication connections.

Bus Terminals

Bus terminals should be designed to accommodate the operations of potentially high volumes of buses and customers. Bus berth requirements are similar to on-street bus stops in terms of lengths and accessibility.

Busway widths should be adequate to accommodate both operating buses and buses laying over. The minimum busway width should be 33 feet. This permits a bus to layover on the left; a bus to pick up at the curb on the right; and a bus to pass between them. At specific non-critical areas, the width can be reduced to 22'.

Bus Stop Maintenance

Well maintained bus stops are crucial to the image of the transit system. Damaged street furniture and trash build-up should be tended to immediately to create a positive impression for transit customers and the general public. The owners of the street furniture have the obligation to maintain their furniture, and the jurisdiction should be responsible for monitoring these items for compliance. Most bus stops are on municipal property. Maintenance frequency is dependent on many factors including location and usage. Repair of items that pose a safety problem should be performed as soon as possible.

General sidewalk maintenance as well as snow and ice removal is generally the responsibility of the entity that owns the sidewalk. Some municipalities require the abutter to perform snow removal. Where there is a shelter present, responsibility varies. For shelters maintained by JC Decaux, the company clears snow and ice from the shelters. Along MBTA Key Bus Routes, MBTA forces remove ice and snow from bus stops. Snow and ice removal must result in clear paths of travel between both bus doors and the sidewalk. Typically this requires that the snow bank be cut through at several locations.

Construction Impacts to Bus Operations

Construction activities by public and/or private entities often impact bus operations and bus stops. Construction impacts can be minimized through stipulations applied to the project. The following information attempts to reduce construction conflicts, provide information for the contractor, and guide local jurisdiction staff coordinating both design and construction work. The MBTA will participate in all decisions on construction that requires temporary stop closures, relocations, and route or service disruptions.

The common mechanism for communicating transit needs to construction contractors is via construction plans and specifications. They usually contain language requiring contractors to maintain access and signage, etc.

The ultimate goal of the MBTA is to provide safe access to and from the bus stop for both pedestrians and bus operators. Typical standard plans and specifications should address the following:

- A minimum 4' wide clear path of travel shall be provided at all times to maintain customer access to, from and around bus stops during construction.
- Temporary access to bus stop zones during construction shall be approved by MBTA in advance of construction activities.
- The MBTA shall be notified at least five business days in advance for all partial or full street closures affecting transit operations regardless of the duration of the closure. This will allow MBTA sufficient time to plan detours and notify bus customers.
- The contractor shall work with MBTA to establish an approved temporary bus stop location.
- The MBTA or the contractor will provide and post the appropriate temporary bus sign signage.
- The contractor shall notify MBTA at least ten days in advance of construction completion so that permanent bus stop signs can be re-installed by MBTA.



Recommended construction plan notes include:

- Contact MBTA for coordination and review requirements.
- Contractor may not remove or relocate any bus stop signs without prior authorization from MBTA.
- All work shall conform to the requirements of the Americans with Disabilities Act (ADA) including provisions for temporary access to and from bus stops.
- Temporary access to bus stop zones during construction shall be approved by MBTA at least 5 days in advance of construction activities.



- The contractor is responsible for all costs incurred for loss or damage to bus stop signs or hardware and street furniture. Project acceptance will be delayed at the request of the local jurisdiction for any damaged street furniture or non-payment of costs.
- Temporary removal of street furniture to avoid damage and conflict during construction requires a 30-day advance notice to both the municipality and the owner of the street furniture.
- The contractor shall provide MBTA with the name and telephone number of the contractor's construction manager prior to the commencement of all construction projects involving bus stops or bus route detours.
- The contractors shall make every effort to schedule their work to minimize impacts and the duration of impacts to transit operations and the general public.
- The contractor is responsible for the construction of the customer boarding area.
- A representative of MBTA should be invited to the project's pre-construction conference

11. TRANSIT PRIORITY MEASURES

Conventional urban bus operations are often characterized by sluggish buses inching their way along congested streets, delayed not only by other vehicles and traffic signals, but also by frequent and time-consuming stops to pick up and discharge customers. On average, buses travel at 60 percent or less of the speeds of automobiles using the same streets.

There are several concepts and technologies widely used today to improve bus service and reduce travel time. The components of travel time include getting to and from bus stops, time waiting for the bus to arrive, and the time spent traveling on the bus. Transit priority measures primarily seek to reduce the customer's waiting time for the bus and the in-vehicle component of travel time by giving buses priority over other types of vehicles on streets and at intersections. These measures include queue jump lanes, exclusive bus lanes and priority treatment for buses at traffic signals. The planning and implementation of bus priority measures works best in urban areas with a high concentration of bus services, high volumes of traffic flow, and good community support for transit service. To be successful, transit priority measures must be coordinated with the local jurisdictions responsible for traffic control and roadway planning and operations. The following sections describe some of the transit priority measures available.

Queue Jump Lanes

Queue jump lanes provide priority treatment for buses by allowing them to bypass traffic queued at congested intersections. Queue jump lanes can be a shared right turn lane, a portion of a parking lane, or an exclusive bus lane. Queue jumps are only effective in certain situations. First, there has to be an existing source of delay or roadway congestion; if there is no congestion and the normal traffic signal is usually green, then the bus driver has no reason to move into the queue jump. Queue jumps may not work well where there are high volumes of right turning vehicles that might get in the way of the bus through movement.

A queue jump lane may be accompanied by a traffic signal that provides a phase specifically for vehicles within the queue jump. Vehicles in the queue jump lane get a "head-start" over other queued vehicles and can therefore merge into the regular travel lanes immediately beyond the signal. The intent of the lane is to allow buses to cut to the front of the queue, reducing the delay caused by the signal. An advance signal does not provide any benefit where's there's a far-side stop because the bus will not be able to merge into traffic during the advance signal phase. Where near-side stops are present, an advance signal can be highly effective in giving the bus a head start, however the bus stop location needs to consider the detection strategy used for the advance signal phase so that the bus is detected only after it is done serving the bus stop. It is preferable to provide a receiving lane on the far side of the intersection to provide an acceleration/merging area, however this is not always a requirement when an advance signal is used.

If the queue jump lane is designated as bus-only, then standard traffic signal detection such as loop detectors can be used. If there is a limited amount of other traffic in the lane, then two or more loop detectors can be used and configured such that only a long vehicle will actuate the advance phase. If the queue jump lane is shared with a higher volume of other traffic, a more high-tech detection scheme

may be needed. Queue jump advance phases are typically 5-10 seconds in duration; longer time may be needed if multiple buses or right turning traffic need to be flushed through the queue jump in one signal cycle. Pedestrian phases can generally run concurrent with a queue jump phase as long as there are no protected turn phases also running with the queue jump phase.

A simpler low cost application of the queue-jump concept involves the use of the queue jump lanes as a shared right-turn/bus lane without the use of an exclusive advance signal. Under this arrangement, the stop location would be at the far side of the intersection. Buses would use the shared lane and advance to the front of the queue at the intersection, and all vehicles would depart the intersection at the same time using the same signal. Buses would stay in the right-hand lane to serve a stop at the far side before merging back into traffic.

The decision to provide queue jump lanes at arterial street intersections should consider the following:

- Does the corridor serve high-frequency bus routes (scheduled headways of 15 minutes or less)?
- Do forecasted traffic volumes and turning movement volumes support the implementation of a queue jump lane?
- Does the intersection currently operate at an unacceptable level of service (defined by local jurisdiction)?
- Is physical space is available and/or can right of way be provided?

The desirable length for a queue jump lane varies depending on traffic volumes and the length of the vehicular traffic queue that might prevent a bus from accessing the queue jump lane. The longer the lane, the greater the potential for parking loss.

Further analysis should be conducted to determine specific warrants for the implementation of queue jump lanes. The analysis should consider travel time benefits for bus customers given varying levels of traffic congestion. The analysis should also consider the potential effect of causing delays to general traffic at the intersection, and/or blocking the transit vehicles travel between intersections.

Exclusive Bus Lanes

Sections of an urban arterial or city street can be reserved for the exclusive or near-exclusive use of buses. This can occur at varying locations along a bus route where space is available. Exclusive bus lanes can be found on the Silver Line-Washington Street and Essex Street, and Broadway in Everett. Typically, parking lanes can be converted to bus lanes-either full time or just during peak periods.

Traffic Signal Priority (TSP)

The goal of TSP is to provide preferential treatment for transit vehicles passing through signalized intersections while minimizing impacts to other vehicles. TSP measures are designed to reduce delays in bus service due to waits at signalized intersections. A bus approaching a downstream traffic signal can extend the green light or advances the cycle to green, either through transponders or other electronic communication means. MBTA buses are equipped with an Automatic Vehicle Location (AVL) system and advanced radio communications that communicate constantly with the MBTA Operations Control Center. There, a computerized system has the ability to determine bus adherence to schedule and can automatically send a signal priority request to a municipality's traffic control center. TSP has the greatest value in restoring proper bus spacing and headways.



APPENDIX A: REFERENCE DOCUMENTS

- NACTO street design guide
<http://nacto.org/publication/transit-street-design-guide/>
- AASHTO: A Policy on Geometric Design of Highways and Streets, 6th Edition
- *ADA Accessible Design Standards-2004*, as adopted by US DOT in 2006
- 2006 *Rules and Regulations of the Massachusetts Architectural Access Board* (521 CMR)
- TCRP Synthesis 117: Better On-Street Bus Stops (2015)
www.TRB.org



APPENDIX B: CONTACT INFORMATION

MBTA Service Planning Department
Curley Champion, Bus Stop Manager
45 High Street, Boston MA
CChampion@mbta.com
(617) 222-5733

MBTA Capital Delivery Department
Erik Scheier, P.E.
10 Park Plaza Suite 5170
Boston MA
Escheier@mbta.com
(617) 222-3214

APPENDIX C: MBTA AMENITY APPROVAL PROCESS

Periodically, requests are made to install shelters and/or benches at bus stops. This can be the result of internal operations or service planning issues or municipal and/or MassDOT requests. The purpose of this matrix is to help guide the review and approval process, which varies depending on the type of alteration.

Request Type		Element/Threshold	Description	Mitigation/Notes
New Bench	New Shelter			
X	X	Ridership	Does the bus stop meet the ridership threshold as per MBTA Bus Stop Guide (Chapter 6&7)?	Thresholds may vary depending on other factors, as described in Guide.
X	X	Sidewalk Width/Path of Travel (POT)	Is a 4' wide clear POT maintained along the sidewalk at the bus stop?	Determine if obstruction to POT can be readily removed.
	X	Landing Pad/Path of Travel (POT)	Does bus stop have an accessible landing pad (5'x8' clear, 2% max. cross slope) within 10-15' of front bus stop sign and is there a POT (4' wide, 2% cross slope) to the sidewalk and the shelter?	Can front bus stop sign be relocated so as to facilitate a compliant landing pad?
X	X	Foundation	Amenity must be secured in place. Is there an existing concrete sidewalk that the amenity can be bolted to, and/or are there features that would prevent construction of a foundation?	If no concrete pad/sidewalk, can one be provided?
	X	Bus Stop length	Is bus stop length adequate? See Chapter 4 for requirements.	If not, can bus stop be lengthened? Will parking and/or roadway impacts be an issue if present?
	X	Crosswalk Connection	Is there a 4' wide clear POT along the sidewalk to nearest crosswalk and connection to reciprocal bus stop?	In this case only, a POT is considered accessible if it is at least 4' wide with a cross slope that does not exceed 4%. A crosswalk is considered accessible if curb ramps on either end have primary slopes not exceeding 12%.
X	X	Amenity Compliance	Does amenity meet ADA Requirements?	They generally do, if supplied by the MBTA



X	X	Installation	Is municipality/proponent/ abutter able to supply and install amenity?	This is preferred option given limited MBTA resources
X	X	Availability	Determine if E&M/Capital Delivery has amenity in stock and/or is able to order.	
X	X	Installation Funding	Determine who will install and funding source.	
X	X	Approvals	Obtain permission from property/sidewalk owner (in most cases, this is the municipality). Will amenity face potential opposition from abutter(s)?	

If various thresholds cannot be met, in most cases construction will be required to meet minimum thresholds and a funding source must be identified.

APPENDIX D: TYPICAL MBTA BUS SHELTER

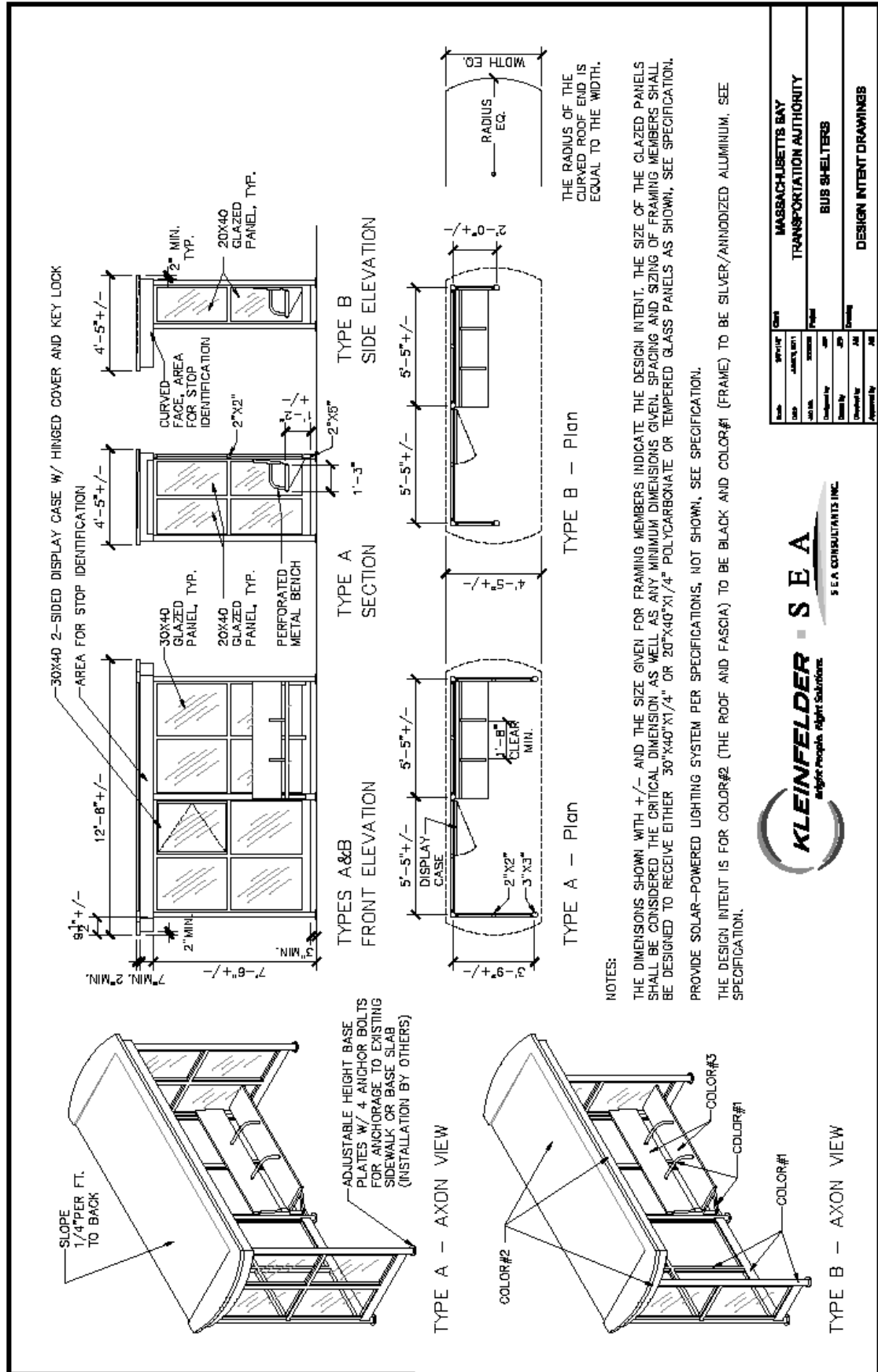

Drawn By	SP/1/16	Checked By	AM
Design No.	AM	Project No.	AM
Scale	AS SHOWN	Sheet No.	AM
Author	AM	Client	AM
Revised By	AM	Contract No.	AM
Approved By	AM	Design Intent	AM

KLEINFELDER S E A
single people. Right Solutions.
 S E A CONSULTANTS INC.

MASSACHUSETTS BAY TRANSPORTATION AUTHORITY
BUS SHELTERS
DESIGN INTENT DRAWINGS